

SCREWLine³

High efficiency air cooled liquid chiller for outdoor installation

WDAT-SL3 200.2 - 580.2 RANGE

Nominal cooling capacity from 467 kW to 1430 kW

- ▶ R-134a double screw compressors
- ▶ Two independent refrigeration circuits
- ▶ Modulating capacity control (stepless) up to 12,5% of the load
- ▶ Chilled water down to -12°C
- ▶ Total / partial recovery of the condensing heat

EXCELLENCE version

- ▶ Eurovent Class A / Up to 52°C outdoor air temperature / Perfect for LEED

PREMIUM version

- ▶ Eurovent Class C / Compact version



Clivet hydronic system

Designed to provide high energy efficiency and sustainability of the investment, the wide range of Clivet liquid chillers and heat pumps for high efficiency air conditioning of Residential and Commercial spaces and for Industrial applications it is available with air or water source.

HYDRONIC System - Air Source

Small and Medium-sized Applications in the Services Sector			Large-sized Applications in the Services and Industry Sectors			
Capacities (A35/W7)	ELFOEnergy Extended Inverter ELFOEnergy Extended Inverter Duct	ELFOEnergy Medium / Vulcan / Large ³ ELFOEnergy Duct Medium	ELFOEnergy Magnum	SPINchiller ³ / SPINchiller Duct Modular Scroll Technology	SCREWLine ³	
	5 ÷ 31 kW	25 ÷ 250 kW	30 ÷ 250 kW	270 ÷ 680 kW	710 ÷ 1360 kW	460 ÷ 1420 kW
Chillers	WSAT-XIN iDC Inverter	WSAT-XEE EXC A PRM C	WSAT-XIN iDC Inverter EXC A PRM C	WSAT-XSC3 EXC A PRM C	WSAT-XSC3 EXC A PRM C	WDAT-SL3 EXC A PRM C
High Temperature Chillers External Air			WSAT-XIN HA iDC Inverter A	WSAT-XSC3 EXC A	WSAT-XSC3 EXC A	WDAT-SL3 EXC A
Free cooling Chillers		WSAT-XEE (FC) A C	WSAT-XIN FC iDC Inverter EXC A PRM C	WSAT-XSC3 FC EXC A	WSAT-XSC3 FC EXC A	WDAT-SL3 FC EXC A
Heat pumps	WSAN-XIN iDC Inverter B	WSAN-XEE A B	WSAN-XIN iDC Inverter EXC A PRM C	WSAN-XSC3 EXC A PRM C	WSAN-XSC3 EXC A PRM C	
Heat pumps High temperature water		WBAN A	WSAN-XIN HW A			
Multifunction heat pump			WSAN-XIN MF iDC Inverter EXC A PRM C	WSAN-XSC3 MF EXC A PRM C	WSAN-XSC3 MF EXC A PRM C	
Ducted units	WSA-XIN iDC Inverter D WSN-XIN (heat pumps) B	WSA-XEE (Chiller) A WSN-XEE (heat pumps) A		WSA-XSC2 (Chiller) A		

Specialization

Every intended use has specific requirements which determine the overall efficiency. For this, the Clivet hydronic system always offers the best solution in every project.

- Modular range with over 8000 kW of overall capacity
- Capacity control with Screw and modular Scroll technology
- Multifunction versions
- Outdoor or indoor (ductable type) installation

Centrality of the Air Renewal

From the Air Renewal depends the comfort in the spaces. Since it often represents the main building energetic load, it also determines the running costs of the entire system.



ZEPHIR3
Packaged Primary Air supply system with thermodynamic energy recovery.

- Simplifies the system, reduces the heating and cooling generators
- Purifies the air with standard electronic filters
- Increases the energy efficiency and it also allows a savings of 40% on the running costs
- From -40°C to +50°C of outdoor air temperature

Terminal and AHU complete system

The hydronic terminal units are very diffused for their versatility and reliability. The Clivet range includes many versions that simplify the application in different types of installation and building.



ELFOspace
High energy efficiency hydronic terminal units
AQX
Air-conditioning unit

- Cased and uncased terminal units, from 1 to 90 kW
- Horizontal and vertical installation
- Energy-saving DC fans
- Modular air conditioning units up to 160.000 m³/h
- EUROVENT certification

SCREWLine³: Screw technology for an efficient and versatile product

SCREWLine³ is the new generation of Clivet liquid chillers with Screw compression technology: high energy efficiency, great operating reliability and maximum choice versatility, with many versions and models for different types of installation.

WDAT-SL3

Air cooled water chiller

- EXCELLENCE high efficiency version and PREMIUM compact version
- Continuous capacity control
- Operating with 52°C of outdoor air temperature
- Total / partial recovery of the condensing heat
- Eurovent certification



WDAT-SL3 FREE-COOLING

Air cooled water chiller with FREE-COOLING

- EXCELLENCE high efficiency version and PREMIUM compact version
- Continuous capacity control
- Direct FREE-COOLING
- Indirect FREE-COOLING (No-Glycol)

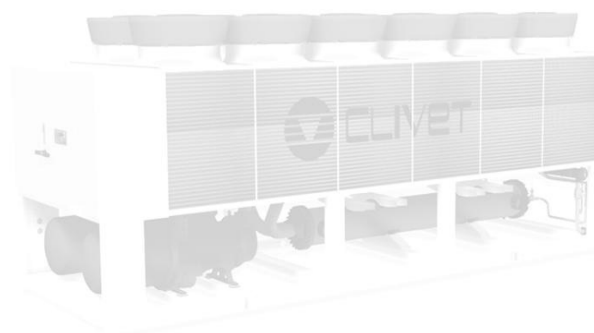

Dedicated series separately documented

Precise and economic operating

In air conditioning of buildings and in industrial processes, thermal loads vary over time. The modulating capacity control (stepless) on two refrigeration circuits continually keeps in balance the Clivet unit with the installation, allowing to:

- follow the load also with a great staging
- save supplying only the necessary energy without fluctuations of electric power input
- stabilize the supplied water temperature

New generation of compressors

The new generation of screw compressors is the result of the continuous evolution for the operating range extension and the overcoming of the traditional efficiency limits at partial load.

New internal geometry, original lubrication system, electronically controlled, innovative capacity modulating control (stepless) up to 12,5% of the load: they are some of the developments that allow an application versatility and the increase of the seasonal efficiency.

Reliable

The load variability involves the continuous variation of the refrigerant volume moved by compressors. The electronic expansion valve (EEV), standard on Clivet units, adapts rapidly and precisely to the actual load required for usage, allowing stable and reliable control in comparison with mechanical thermostatic valves (TEV). This results also in a further increase in efficiency and longer compressor life.

The overheating control allows preventing phenomena that are hazardous to the compressors, such as overtemperature and return fluids, thereby increasing even more efficiency and durability.

Innovative shell and tube exchangers

The Clivet thermodynamic research and the development focused on geometries and materials have led to the use of a new direct expansion shell and tube evaporator for both circuits:

- minimum temperature difference (approach) between refrigerant and leaving water
- the efficiency further increases in all load conditions where only one compressor is operating
- minimum quantity of refrigerant inside the installation

Efficient and silent ventilation technology

Also the innovative air handling system on the external exchangers is the result of the Clivet design evolution. The new AxiTop diffuser creates an ideal air distribution: it aerodynamically decelerates the flow and transforms a big part of its dynamic energy in static pressure, obtaining:

- -3 dB of sound reduction
- reduction of 3% of the absorbed energy

Moreover all units are supplied with a condensation electronic control. It automatically reduces the fan speed as the heat load drops.

Since fans are the unit's main noise source, the benefits are evident especially during the night hours, when the load is reduced but sensitivity to noise is enhanced.

All this translates into a reduction of sound pressure down to 8 dB(A) compared to full load operation in 90% of operating time of the unit.

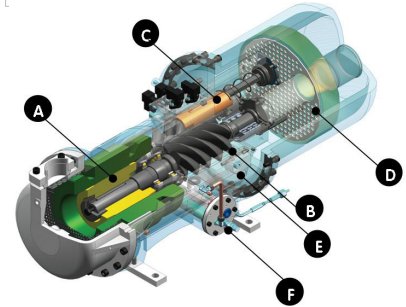
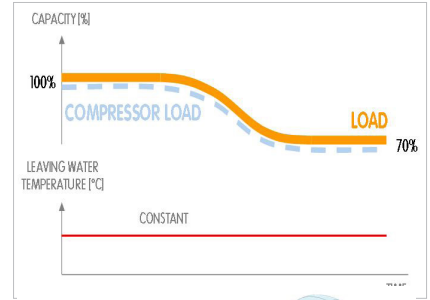

A Electric motor
B Twin screw rotor
C Continuous capacity control
D Oil separator
E Economiser door
F Oil level sensor

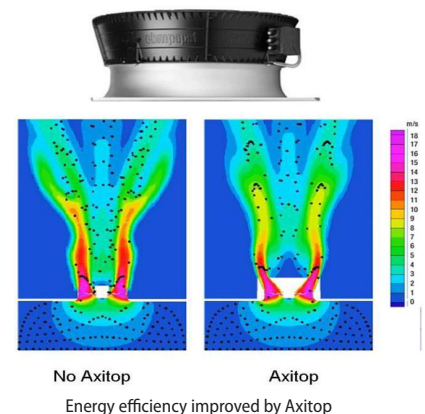
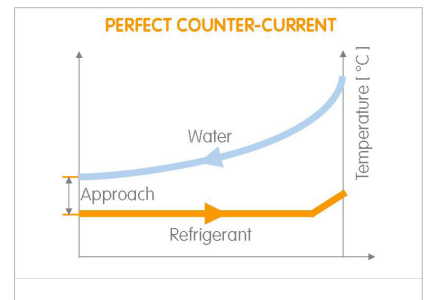
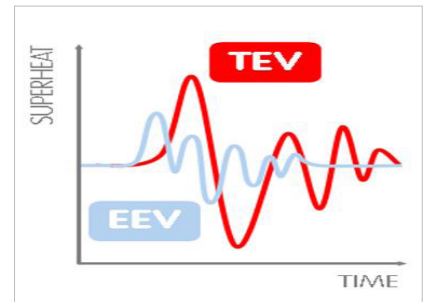

No Axitop Axitop
Energy efficiency improved by Axitop

Advanced integrated pumping system

Searching the maximum overall efficiency, also the energy used for the heat transfer fluid pumping has its importance.

HYDROPACK technology developed by Clivet reduces consumptions and offers an exceptional functional reliability at the same time.

HYDROPACK uses groups of two or three pumps in parallel. It automatically reduces the water flow-rate under critical conditions, avoiding blocks for overload and consequent interventions of specialized technical personnel. It is very useful during start-ups, at restart after operating breaks or after a long period of inactivity.

Thanks to its modularity, HYDROPACK keeps a good water circulation in the installation also if one pump is temporary unavailable. With a deactivated pump, the residual flow-rate is in fact:

- about 80% of the nominal flow-rate (HYDROPACK with 3 pumps)
- about 60% of the nominal flow-rate (HYDROPACK with 2 pumps)

HYDROPACK

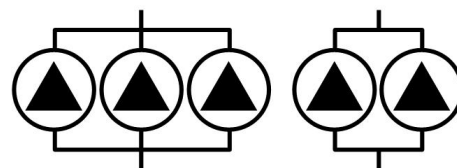

Perfect for LEED certification

The whole EXCELLENCE range satisfies both requirements 2 (Minimum Energy Performance) and 3 (Fundamental Refrigerant Management) of Energy and Atmosphere section. They also meet Credit 4 parameters (Enhanced Refrigerant Management) allowing 2 points acquisition.

Clivet is committed in promoting the green building principles and has become a member of GBC Italia. This organization collaborates with USGBC, the U.S. nonprofit organization that promotes worldwide the LEED system of independent certification.



Two versions for each business

The standard EXCELLENCE version stands out for its extremely high energy efficiency ratio (EER) during full-load cooling, which exceeds the value 3.1 and places it in Eurovent Energy Efficiency class A. It is the best choice for the overall cost reduction throughout the lifespan of the system. Thanks to the generous component sizing, the standard EXCELLENCE is also specialized in the applications with high outdoor air temperature. Reliable and efficient with outdoor air temperature up to 48°C at full load, it is equipped with extended operating at partial load up to 52°C, offering high performances, continuous operating and reduced operating and maintenance costs.

The optional PREMIUM version features the exchanger and structure compact design. It is mainly designed, therefore, for installations focusing on the initial investment.

The advantages of the modular solution

In the event of particularly large buildings requiring high capacities, it is advisable to use several units. The ECOSHARE technology developed by Clivet allows to coordinate up to 7 units in local network, in parallel with modular logic, with the following advantages:

- greater efficiency, because the compressors are sequentially activated exploiting at most their point of operating with the lowest consumption, and the pumping units are activated only when necessary
- greater flexibility, thanks to capability of the automatic control to follow the load
- increased reliability, since the malfunction of one unit does not compromise the capacity supply of the other units.

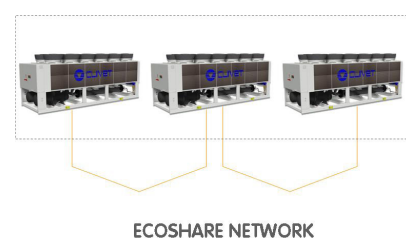

Remote system management

The unit is standard equipped with:

- potential-free contact for remote on/off control
- potential-free contacts for the compressor status display
- setting from user interface: Off / local On / serial On
- potential-free contact to remote a general alarm

Thanks to the different communication protocols available, the unit is able to exchange information with the main supervisory systems using serial connections.

Modbus®

BACnet™

LONWORKS

Unit configuration

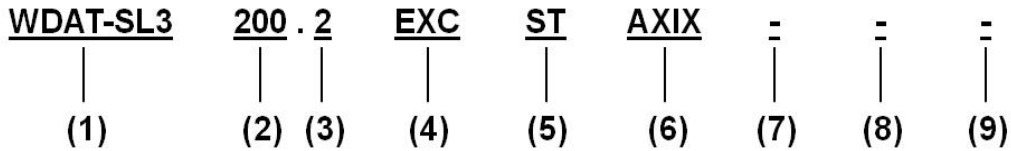

(1) Range

WDAT = Liquid chiller, air cooled, with screw compressors
 SL3 = SCREWLine³ range

(2) Size

200 = Nominal compressor capacity (HP)

(3) Compressors

2 = Compressor quantity

(4) Energy efficiency

EXC = EXCELLENCE version: high energy efficiency
 PRM = Compact PREMIUM version

(5) Acoustic configuration

ST = Standard acoustic configuration (standard)
 SC = Acoustic configuration with compressor soundproofing
 EN = Super-silenced acoustic configuration

(6) Fan diffusers

AXIX - Diffuser for high efficiency fan (standard - separately supplied)
 NAXI - Diffuser not required

(7) Condensation heat recovery

(-) recovery not required (standard)
 D - Partial energy recovery (15% of available heat)
 R - Total energy recovery (100% of available heat)

(8) Low evaporator water temperature configuration

(-) Low water temperature: not required (standard)
 B - Low water temperature, down to -8°C (Brine)

(9) Pumping unit

(-) not required
 2PM - Hydropack with no. 2 of pumps
 3PM - Hydropack con no. 3 of pumps

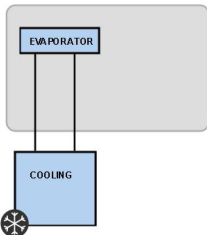
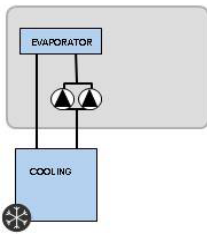
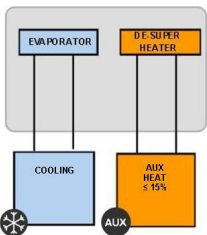
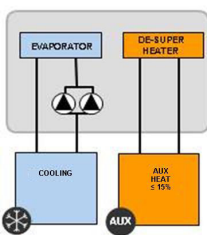
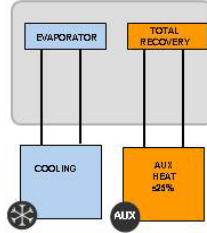
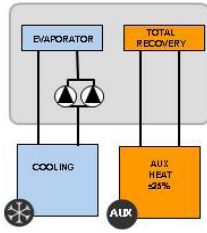
Functionalities	Hydronic units	
2-PIPE SYSTEM Chilled water production for installation	1.1 Standard unit 	1.2 Standard unit with HYDROPACK 
	2.1 Standard unit with partial recovery 	2.2 Standard unit with partial recovery and HYDROPACK 
2-PIPE SYSTEM + PARTIAL RECOVERY Production of chilled water Free production of hot water from partial recovery	3.1 Standard unit with total recovery 	3.2 Standard unit with total recovery and HYDROPACK 
	2-PIPE SYSTEM + TOTAL RECOVERY Chilled water production for installation Hot water free production from total recovery	

Accessories separately supplied

• **RCMRX** - Remote control via microprocessor remote control

• **PSX** - Mains power supply unit

• **AMMX** - Spring antivibration mounts

Further considerations on the installation

The vast operating field of SCREWLine³ allows it to adapt to most system applications.

In some cases, special duty conditions may exceed the unit operating range.

Simple devices on the system allow proper operation and meeting any requirement.

Here are two examples.

Water flow-rate values outside the limits

SCREWLine³ operates with constant water flow-rate to the evaporator, between a minimum and maximum value indicated in the technical documents.

Flow-rate values below the limit may cause unwanted formation of ice, incrustations, reduced control precision, and the unit to stop following the intervention of built-in safety devices.

Flow values above the limit may cause high pressure drops, high pumping costs, and reduced control precision, and erosion damages to the exchangers.

In this example, the required flow-rate is lower than the maximum value allowed to the evaporator, while the operating temperatures fall within the functional field of the unit.

A properly sized bypass piping resolves the problem.

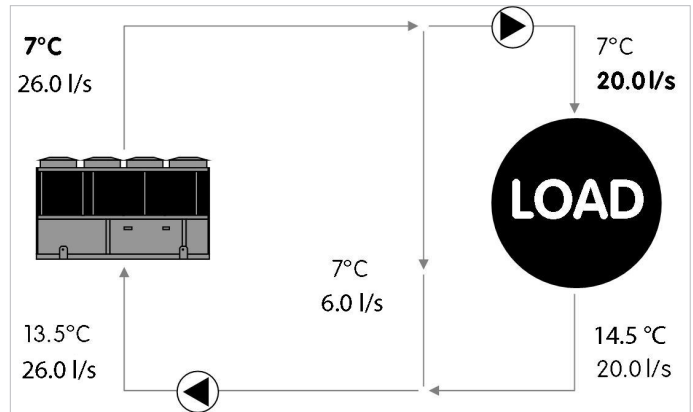

Example referred to WDAT-SL3 280.2 EXCELLENCE version. Appropriate water flow-rate for the correct unit operation.

Temperature values outside the limits

SCREWLine³ operates with the system supply temperatures indicated in the technical documentation.

Temperature limits below the limit may cause unwanted formation of ice and the unit to stop following the intervention of built-in safety devices.

Temperature values under the limit may cause malfunctions and damages to the compressors, reduced control precision, and the unit to stop following the intervention of built-in safety devices.

In this example, the required temperature exceeds the maximum value allowed to the evaporator, while the water flow-rate falls within the functional field of the unit.

A properly sized bypass piping and mixing system resolve the problem.

Should both the water flow-rate and the operating temperature exceed the values intended for the chiller, all you have to do is combine the two cases described above.

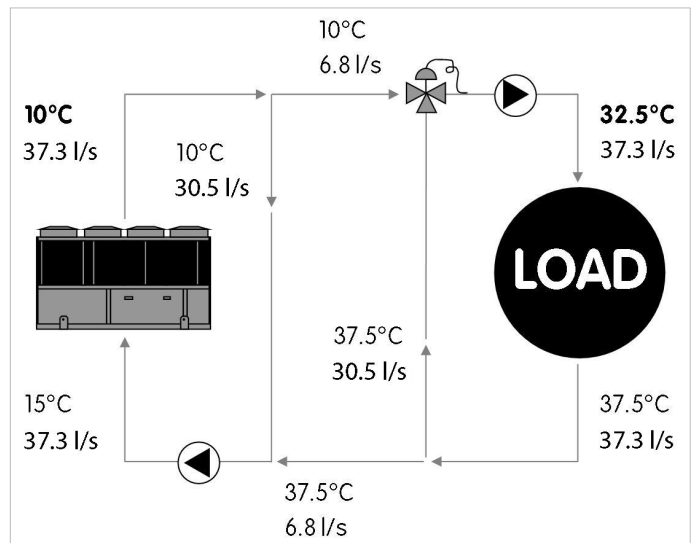

Example referred to WDAT-SL3 280.2 EXCELLENCE version. Appropriate supply water temperature for the correct unit operation. Nominal water flow-rate with water 15°C-10°C

Evaporator thermal gradient

SCREWLine³ nominal capacities refer to an evaporator thermal gradient equal to 5 °C. A different thermal gradient may be used in full load operation, provided that both the operating flow and temperatures fall within the limits. As an indication, this corresponds to a minimum thermal gradient of approximately 4 °C and a maximum of 7 °C (the exact values must be determined based on the allowed flows and temperatures).

EXCELLENCE VERSION

Acoustic configuration: standard (ST) / compressor soundproofing (SC)

General technical data - Performance

Size			200.2	210.2	220.2	240.2	260.2	280.2	320.2	340.2	360.2	400.2	440.2	500.2	540.2	580.2
Cooling																
Cooling capacity	1	[kW]	486	510	550	585	637	709	783	839	902	979	1099	1218	1321	1430
Compressor power input	1	[kW]	141	149	158	168	186	204	224	241	260	286	325	352	387	415
Total power input	2	[kW]	154	162	173	184	202	223	244	264	283	311	351	383	418	447
Partial recovery heating capacity	3	[kW]	94,1	98,8	106	113	123	137	151	162	174	190	214	236	256	277
Total recovery heating capacity	3	[kW]	666	710	777	872	915	958	1028	1093	1206	1350	1405	1478	1613	1721
EER	1	-	3,15	3,15	3,17	3,18	3,15	3,18	3,21	3,18	3,19	3,15	3,13	3,18	3,16	3,20
Water flow-rate (User Side)	1	[l/s]	23,2	24,4	26,3	28,0	30,4	33,9	37,4	40,1	43,1	46,8	52,5	58,2	63,1	68,3
Internal exchanger pressure drops	1	[kPa]	42	46	32	36	42	51	53	60	68	27	33	57	66	76
Cooling capacity (EN14511:2013)	4	[kW]	484	508	549	583	635	706	780	835	898	977	1096	1213	1315	1423
Total power input (EN14511:2013)	4	[kW]	156	164	175	186	204	226	247	267	287	313	353	388	424	454
EER (EN 14511:2013)	4	-	3,10	3,10	3,14	3,14	3,11	3,13	3,16	3,13	3,13	3,12	3,10	3,13	3,10	3,13
ESEER	4	-	4,00	4,00	4,05	4,06	4,01	4,03	4,07	4,03	4,04	4,02	4,00	4,03	4,00	4,04
Cooling capacity (AHRI 550/590)	5	[kW]	483	506	546	580	632	703	777	830	889	971	1089	1209	1312	1419
Total power input (AHRI 550/590)	5	[kW]	154	161	173	183	201	223	243	262	280	310	350	383	417	446
COPR	5	-	3,14	3,14	3,16	3,16	3,14	3,16	3,19	3,16	3,17	3,13	3,11	3,16	3,15	3,18
IPLV	5	-	4,50	4,47	4,55	4,56	4,49	4,53	4,55	4,50	4,51	4,52	4,49	4,52	4,50	4,53

- Data referred to the following conditions: internal exchanger water = 12/7 °C. Entering external exchanger air temperature 35°C. Evaporator fouling factor = 0.44×10^{-4} m² K/W
- The Total Power Input value does not take into account the part related to the pumps and required to overcome the pressure drops for the circulation of the solution inside the exchangers
- Recovery exchanger water=40/45°C
- Data compliant to Standard EN 14511:2013 referred to the following conditions: - Internal exchanger water temperature = 12/7°C - Entering external exchanger air temperature = 35°C
- Data compliant to Standard AHRI 550/590 referred to the following conditions: internal exchanger water temperature = 6,7 °C. Water flow-rate 0,043 l/s per kW. Entering external exchanger air temperature 35°C. Evaporator fouling factor = 0.18×10^{-4} m² K/W

PREMIUM VERSION

Acoustic configuration: standard (ST) / compressor soundproofing (SC)

General technical data - Performance

Size			200.2	210.2	220.2	240.2	260.2	280.2	320.2	340.2	360.2	400.2	440.2	500.2	540.2	580.2
Cooling																
Cooling capacity	1	[kW]	468	490	514	560	601	668	744	785	837	916	1026	1142	1260	1359
Compressor power input	1	[kW]	148	158	168	180	200	225	245	262	286	314	354	390	433	450
Total power input	2	[kW]	160	171	181	193	213	241	261	281	305	333	377	413	458	476
Partial recovery heating capacity	3	[kW]	92,3	97,2	102	111	120	134	148	157	168	184	207	230	254	271
Total recovery heating capacity	3	[kW]	653	696	761	855	897	939	1007	1071	1182	1323	1377	1448	1581	1687
EER	1	-	2,92	2,87	2,84	2,90	2,83	2,78	2,85	2,79	2,74	2,75	2,72	2,77	2,75	2,86
Water flow-rate (User Side)	1	[l/s]	22,4	23,4	24,6	26,8	28,7	31,9	35,5	37,5	40,0	43,8	49,0	54,6	60,2	64,9
Internal exchanger pressure drops	1	[kPa]	31	33	37	47	53	46	55	61	60	70	29	36	61	70
Cooling capacity (EN14511:2013)	4	[kW]	467	489	512	558	599	666	741	781	833	912	1024	1139	1255	1353
Total power input (EN14511:2013)	4	[kW]	162	172	182	195	215	243	264	284	309	337	379	416	463	482
EER (EN 14511:2013)	4	-	2,89	2,84	2,81	2,86	2,79	2,74	2,80	2,75	2,70	2,70	2,70	2,74	2,71	2,81
ESEER	4	-	3,93	3,86	3,82	3,89	3,79	3,73	3,81	3,74	3,67	3,68	3,67	3,73	3,68	3,82
Cooling capacity (AHRI 550/590)	5	[kW]	458	481	506	551	595	663	735	779	833	907	1020	1135	1256	1342
Total power input (AHRI 550/590)	5	[kW]	159	169	180	192	212	239	260	279	302	331	376	411	458	474
COPR	5	-	2,88	2,84	2,81	2,87	2,80	2,77	2,83	2,79	2,76	2,74	2,72	2,76	2,74	2,83
IPLV	5	-	4,40	4,31	4,26	4,36	4,23	4,18	4,29	4,20	4,13	4,12	4,13	4,17	4,11	4,28

- Data referred to the following conditions: internal exchanger water = 12/7 °C. Entering external exchanger air temperature 35°C. Evaporator fouling factor = 0.44×10^{-4} m² K/W
- The Total Power Input value does not take into account the part related to the pumps and required to overcome the pressure drops for the circulation of the solution inside the exchangers
- Recovery exchanger water=40/45°C
- Data compliant to Standard EN 14511:2013 referred to the following conditions: - Internal exchanger water temperature = 12/7°C - Entering external exchanger air temperature = 35°C
- Data compliant to Standard AHRI 550/590 referred to the following conditions: internal exchanger water temperature = 6,7 °C. Water flow-rate 0,043 l/s per kW. Entering external exchanger air temperature 35°C. Evaporator fouling factor = 0.18×10^{-4} m² K/W

EXCELLENCE VERSION

Acoustic configuration: super-silenced (EN)

General technical data - Performance

Size			200.2	210.2	220.2	240.2	260.2	280.2	320.2	340.2	360.2	400.2	440.2	500.2
Cooling														
Cooling capacity	1	kW	474	502	529	571	623	692	775	822	874	962	1066	1173
Compressor power input	1	kW	147	155	163	175	193	212	231	247	269	295	332	363
Total power input	2	kW	151	160	167	181	198	218	238	254	276	304	340	372
Partial recovery heating capacity	3	kW	93,1	98,6	104	112	122	136	151	160	171	189	210	230
Total recovery heating capacity	3	kW	666	710	777	872	915	958	1028	1093	1206	1350	1405	1478
EER	1		3,14	3,14	3,16	3,16	3,15	3,17	3,25	3,23	3,16	3,17	3,13	3,15
Water flow-rate (User Side)	1		22,6	24,0	25,3	27,3	29,8	33,1	37,0	39,3	41,8	46,0	50,9	56,0
Internal exchanger pressure drops	1		32	35	30	35	40	43	52	58	65	26	31	54
Cooling capacity (EN14511:2013)	4	kW	473	501	528	569	621	690	772	819	870	960	1063	1169
Total power input (EN14511:2013)	4	kW	152	161	169	182	200	220	241	258	280	306	343	377
EER (EN 14511:2013)	4	-	3,10	3,10	3,13	3,13	3,10	3,13	3,20	3,18	3,10	3,14	3,10	3,10
ESEER	4	-	4,12	4,13	4,16	4,16	4,13	4,16	4,26	4,22	4,13	4,18	4,13	4,13
Cooling capacity (AHRI 550/590)	5	kW	471	499	524	566	619	685	768	813	867	955	1057	1157
Total power input (AHRI 550/590)	5	kW	151	159	166	180	197	217	237	253	275	302	339	370
COPR	5	-	3,13	3,13	3,15	3,15	3,14	3,16	3,24	3,21	3,15	3,16	3,12	3,13
IPLV	5	-	4,64	4,61	4,65	4,64	4,63	4,65	4,75	4,73	4,61	4,69	4,62	4,63

- Data referred to the following conditions: internal exchanger water = 12/7 °C. Entering external exchanger air temperature 35°C. Evaporator fouling factor = 0.44×10^{-4} m² K/W
- The Total Power Input value does not take into account the part related to the pumps and required to overcome the pressure drops for the circulation of the solution inside the exchangers
- Recovery exchanger water=40/45°C
- Data compliant to Standard EN 14511:2013 referred to the following conditions: - Internal exchanger water temperature = 12/7°C - Entering external exchanger air temperature = 35°C
- Data compliant to Standard AHRI 550/590 referred to the following conditions: internal exchanger water temperature = 6,7 °C. Water flow-rate 0,043 l/s per kW. Entering external exchanger air temperature 35°C. Evaporator fouling factor = 0.18×10^{-4} m² K/W

PREMIUM VERSION

Acoustic configuration: super-silenced (EN)

General technical data - Performance

Size			200.2	210.2	220.2	240.2	260.2	280.2	320.2	340.2	360.2	400.2	440.2	500.2	540.2	580.2
Cooling																
Cooling capacity	1	[kW]	448	469	504	533	593	656	723	772	829	903	1017	1134	1243	1316
Compressor power input	1	[kW]	160	168	174	191	209	228	250	269	291	319	353	396	432	464
Total power input	2	[kW]	164	172	178	195	214	233	255	275	297	325	361	405	441	473
Partial recovery heating capacity	3	[kW]	91,3	95,6	101,7	108,6	120,4	13,6	145,9	156,2	168	183,3	205,6	229,5	251,3	266,9
Total recovery heating capacity	3	[kW]	653	696	761	855	897	939	1007	1071	1182	1323	1377	1448	1581	1687
EER	1	-	2,73	2,73	2,83	2,74	2,77	2,82	2,83	2,81	2,79	2,77	2,82	2,80	2,82	2,78
Water flow-rate (User Side)	1	[l/s]	21,4	22,4	24,1	25,5	28,3	31,3	34,5	36,9	39,6	43,1	48,6	54,2	59,4	62,9
Internal exchanger pressure drops	1	[kPa]	28	31	35	43	52	44	52	61	54	61	29	35	60	66
Cooling capacity (EN14511:2013)	4	[kW]	447	468	503	531	591	654	720	769	826	899	1015	1131	1238	1310
Total power input (EN14511:2013)	4	[kW]	165	173	179	197	216	235	258	278	300	329	363	408	446	478
EER (EN 14511:2013)	4	-	2,70	2,70	2,80	2,70	2,73	2,78	2,79	2,76	2,75	2,73	2,80	2,78	2,77	2,74
ESEER	4	-	3,73	3,68	3,84	3,73	3,77	3,81	3,85	3,79	3,74	3,76	3,80	3,83	3,77	3,78
Cooling capacity (AHRI 550/590)	5	[kW]	445	461	497	528	587	649	720	764	821	894	1009	1124	1221	1292
Total power input (AHRI 550/590)	5	[kW]	164	170	177	194	213	231	255	273	296	323	359	401	437	468
COPR	5	-	2,72	2,71	2,81	2,73	2,76	2,80	2,83	2,80	2,77	2,76	2,81	2,80	2,79	2,76
IPLV	5	-	4,19	4,13	4,30	4,18	4,24	4,26	4,30	4,26	4,19	4,23	4,25	4,29	4,24	4,24

- Data referred to the following conditions: internal exchanger water = 12/7 °C. Entering external exchanger air temperature 35°C. Evaporator fouling factor = 0.44×10^{-4} m² K/W
- The Total Power Input value does not take into account the part related to the pumps and required to overcome the pressure drops for the circulation of the solution inside the exchangers
- Recovery exchanger water=40/45°C
- Data compliant to Standard EN 14511:2013 referred to the following conditions: - Internal exchanger water temperature = 12/7°C - Entering external exchanger air temperature = 35°C
- Data compliant to Standard AHRI 550/590 referred to the following conditions: internal exchanger water temperature = 6,7 °C. Water flow-rate 0,043 l/s per kW. Entering external exchanger air temperature 35°C. Evaporator fouling factor = 0.18×10^{-4} m² K/W

VERSION: EXCELLENCE

Acoustic configuration: standard (ST) / compressor soundproofing (SC)

General technical data - Construction

Size		200.2	210.2	220.2	240.2	260.2	280.2	320.2	340.2	360.2	400.2	440.2	500.2	540.2	580.2	
Compressor																
Type of compressors	1	-	DSW	DSW	DSW	DSW	DSW	DSW	DSW	DSW	DSW	DSW	DSW	DSW	DSW	DSW
No. of compressors		-	2	2	2	2	2	2	2	2	2	2	2	2	2	2
Rated power (C1)		[HP]	100	100	110	120	120	140	160	160	180	200	220	250	270	290
Nominal capacity (C2)		[HP]	100	110	110	120	140	140	160	180	180	200	220	250	270	290
Std Capacity control steps		-	STEPLESS	STEPLESS	STEPLESS	STEPLESS	STEPLESS	STEPLESS	STEPLESS	STEPLESS	STEPLESS	STEPLESS	STEPLESS	STEPLESS	STEPLESS	STEPLESS
Oil charge (C1)		[l]	17	17	17	17	17	21	21	21	25	25	25	25	30	30
Oil charge (C2)		[l]	17	17	17	17	21	21	21	25	25	25	25	25	30	30
Refrigerant charge (C1)		[kg]	72	72	69	80	80	97	97	95	108	124	126	142	160	161
Refrigerant charge (C2)		[kg]	69	69	69	80	81	97	97	114	114	130	135	150	169	170
Refrigeration circuits		-	2	2	2	2	2	2	2	2	2	2	2	2	2	2
Internal exchanger																
Type of internal exchanger	2	-	S&T	S&T	S&T	S&T	S&T	S&T	S&T	S&T	S&T	S&T	S&T	S&T	S&T	S&T
N. of internal exchanger		-	1	1	1	1	1	1	1	1	1	1	1	1	1	1
Water content		[l]	222	222	307	307	307	280	280	280	280	481	481	514	514	514
External exchanger																
Frontal surface		m ²	18,7	18,7	23,4	23,4	23,4	28,1	28,1	32,8	32,8	37,4	37,4	46,8	46,8	46,8
External Section Fans																
Type of fans	3	-	AX	AX	AX	AX	AX	AX	AX	AX	AX	AX	AX	AX	AX	AX
Number of fans		-	8	8	10	10	10	12	12	14	14	16	16	20	20	20
Type of motor	4	-	AC/P	AC/P	AC/P	AC/P	AC/P	AC/P	AC/P	AC/P	AC/P	AC/P	AC/P	AC/P	AC/P	AC/P
Standard airflow		[l/s]	48000	48000	61000	60000	59000	72000	70000	84000	82000	97000	94000	123000	121000	117000
Connections																
Water fittings		-	8"	8"	6"	6"	6"	6"	6"	6"	6"	8"	8"	8"	8"	8"
Power supply																
Standard power supply		-	400/3~/50	400/3~/50	400/3~/50	400/3~/50	400/3~/50	400/3~/50	400/3~/50	400/3~/50	400/3~/50	400/3~/50	400/3~/50	400/3~/50	400/3~/50	400/3~/50
Electrical data																
FLA Total		A	370	388	414	440	489	546	600	648	687	751	819	916	982	1047
FLI Total		kW	225	236	251	268	292	321	353	381	405	442	493	545	594	634
M.I.C. - Value	5	A	356	409	427	436	432	473	559	657	687	712	809	956	1096	1253
M.I.C. - with soft start accessory	5	A	517	598	616	630	615	656	786	978	1008	1034	1168	1380	1669	1853

- DSW = double screw compressor
- S&T = shell and tube
- AX = axial fan
- AC/P = asynchronous three-phase external rotor motor with phase cutting speed automatic control

- Unbalance between phase max 2 % Voltage variation: max +/- 10%
 Electrical data refer to standard units; according to the installed accessories, the data can suffer some variations.
 5. M.I.C. = compressor 2 starting current + compressor 1 current at 75% of the max load + circuit 1 fan

Sound levels - ST configuration

Size	Sound power level (dB)								Sound power level	Sound pressure level
	Octave band (Hz)									
	63	125	250	500	1000	2000	4000	8000		
200.2	107	98	90	95	100	75	77	72	101	81
210.2	107	99	94	94	100	76	77	72	101	81
220.2	108	100	97	94	100	77	78	74	101	81
240.2	108	100	96	96	100	78	79	74	101	81
260.2	108	99	95	95	100	83	83	75	101	80
280.2	110	100	94	96	100	86	86	76	101	80
320.2	110	100	94	96	100	86	86	76	101	80
340.2	111	101	96	97	101	88	87	77	103	81
360.2	111	101	97	98	102	88	87	78	104	82
400.2	112	102	99	97	104	87	86	78	105	83
440.2	112	102	96	104	106	87	86	78	107	85
500.2	113	103	97	96	107	91	89	79	108	86
540.2	113	103	100	96	109	88	90	79	109	87
580.2	113	103	97	98	109	91	89	79	109	87

Sound levels refer to full load units, in test nominal conditions. The sound pressure level refers to 1 m. from the standard unit outer surface operating in open field. Measures according to UNI EN ISO 9614-2 regulations, with respect to the EUROVENT 8/1 certification. Data referred to the following conditions:
 internal exchanger water = 12/7 °C Ambient temperature = 35 °C

Sound levels - SC configuration

Size	Sound power level (dB)								Sound power level	Sound pressure level
	Octave band (Hz)									
	63	125	250	500	1000	2000	4000	8000		
200.2	107	98	86	92	97	73	76	72	98	77
210.2	107	98	90	92	97	74	76	72	98	77
220.2	108	99	92	92	97	75	77	74	98	77
240.2	108	99	91	94	97	76	77	74	98	77
260.2	108	99	90	93	96	81	79	74	98	77
280.2	110	100	90	94	96	84	81	75	98	77
320.2	110	100	90	94	97	84	81	75	98	77
340.2	111	101	91	95	98	85	82	76	100	78
360.2	111	101	92	96	99	86	82	76	100	79
400.2	112	102	95	95	101	84	82	77	102	80
440.2	112	102	92	101	102	85	82	77	104	82
500.2	113	103	92	95	104	89	84	78	105	82
540.2	113	103	96	94	105	86	85	78	106	83
580.2	113	103	92	96	105	89	84	78	106	83

Sound levels refer to full load units, in test nominal conditions. The sound pressure level refers to 1 m. from the standard unit outer surface operating in open field. Measures according to UNI EN ISO 9614-2 regulations, with respect to the EUROVENT 8/1 certification. Data referred to the following conditions:
 internal exchanger water = 12/7 °C Ambient temperature = 35 °C

VERSION: PREMIUM

Acoustic configuration: standard (ST) / compressor soundproofing (SC)

General technical data - Construction

Size		200.2	210.2	220.2	240.2	260.2	280.2	320.2	340.2	360.2	400.2	440.2	500.2	540.2	580.2	
Compressor																
Type of compressors	1	-	DSW	DSW	DSW	DSW	DSW	DSW	DSW	DSW	DSW	DSW	DSW	DSW	DSW	DSW
No. of compressors		-	2	2	2	2	2	2	2	2	2	2	2	2	2	2
Rated power (C1)		[HP]	100	100	110	120	120	140	160	160	180	200	220	250	270	290
Nominal capacity (C2)		[HP]	100	110	110	120	140	140	160	180	180	200	220	250	270	290
Std Capacity control steps		-	STEPLESS	STEPLESS	STEPLESS	STEPLESS	STEPLESS	STEPLESS	STEPLESS	STEPLESS	STEPLESS	STEPLESS	STEPLESS	STEPLESS	STEPLESS	STEPLESS
Oil charge (C1)		[l]	17	17	17	17	17	21	21	21	25	25	25	25	30	30
Oil charge (C2)		[l]	17	17	17	17	21	21	21	25	25	25	25	25	30	30
Refrigerant charge (C1)		[kg]	63	63	63	73	73	73	82	83	87	98	115	115	131	132
Refrigerant charge (C2)		[kg]	60	60	60	70	74	73	82	87	87	98	124	124	140	141
Refrigeration circuits		-	2	2	2	2	2	2	2	2	2	2	2	2	2	2
Internal exchanger																
Type of internal exchanger	2	-	S&T	S&T	S&T	S&T	S&T	S&T	S&T	S&T	S&T	S&T	S&T	S&T	S&T	S&T
N. of internal exchanger		-	1	1	1	1	1	1	1	1	1	1	1	1	1	1
Water content		[l]	238	238	238	233	233	280	280	280	280	280	481	481	514	514
External exchanger																
Frontal surface		m ²	18,7	18,7	18,7	18,7	18,7	23,4	23,4	28,1	28,1	28,1	32,8	32,8	37,4	37,4
External Section Fans																
Type of fans	3	-	AX	AX	AX	AX	AX	AX	AX	AX	AX	AX	AX	AX	AX	AX
Number of fans		-	8	8	8	8	8	10	10	12	12	12	14	14	16	16
Type of motor	4		AC/P	AC/P	AC/P	AC/P	AC/P	AC/P	AC/P	AC/P	AC/P	AC/P	AC/P	AC/P	AC/P	AC/P
Standard airflow		[l/s]	49000	49000	49000	48000	50000	61000	60000	74000	74000	72000	85000	82000	97000	94000
Connections																
Water fittings		-	8"	8"	8"	8"	8"	6"	6"	6"	6"	6"	8"	8"	8"	8"
Power supply																
Standard power supply		V	400/3~/50	400/3~/50	400/3~/50	400/3~/50	400/3~/50	400/3~/50	400/3~/50	400/3~/50	400/3~/50	400/3~/50	400/3~/50	400/3~/50	400/3~/50	400/3~/50
Electrical data																
FLA Total		A	370	388	406	432	480	537	591	639	679	735	811	892	966	1031
FLI Total		kW	225	236	248	263	288	317	349	377	401	435	490	534	586	626
M.I.C. - Value	5	A	356	409	423	432	428	469	555	653	683	704	805	944	1088	1245
M.I.C. - with soft start accessory	5	A	517	598	612	626	611	652	782	974	1004	1026	1164	1368	1661	1845

1. DSW = double screw compressor

2. S&T = shell and tube

3. AX = axial fan

4. AC/P = asynchronous three-phase external rotor motor with phase cutting speed automatic control

Unbalance between phase max 2 %

Voltage variation: max +/- 10%

Electrical data refer to standard units; according to the installed accessories, the data can suffer some variations.

5. M.I.C. = compressor 2 starting current + compressor 1 current at 75% of the max load + circuit 1 fan

Sound levels - ST configuration

Size	Sound power level (dB)								Sound power level	Sound pressure level
	Octave band (Hz)									
	63	125	250	500	1000	2000	4000	8000		
200.2	107	98	90	95	100	75	77	72	101	81
210.2	107	99	94	94	100	76	77	72	101	81
220.2	107	99	96	94	100	77	77	72	101	80
240.2	107	99	95	95	100	77	78	73	101	81
260.2	107	98	94	95	99	83	82	74	101	80
280.2	108	99	93	95	99	85	85	75	101	80
320.2	108	99	93	95	99	86	85	76	101	80
340.2	110	100	95	97	101	87	86	77	102	81
360.2	110	100	96	98	102	88	87	77	103	82
400.2	110	100	98	96	104	86	86	76	104	83
440.2	111	101	96	103	105	86	86	77	107	85
500.2	111	101	95	95	106	90	88	77	107	85
540.2	112	102	99	95	108	88	89	78	109	87
580.2	112	102	96	98	108	90	89	78	108	87

Sound levels refer to full load units, in test nominal conditions. The sound pressure level refers to 1 m. from the standard unit outer surface operating in open field. Measures according to UNI EN ISO 9614-2 regulations, with respect to the EUROVENT 8/1 certification. Data referred to the following conditions.

internal exchanger water = 12/7 °C Ambient temperature = 35 °C

Sound levels - SC configuration

Size	Sound power level (dB)								Sound power level	Sound pressure level
	Octave band (Hz)									
	63	125	250	500	1000	2000	4000	8000		
200.2	108	98	86	93	97	74	76	73	98	77
210.2	108	98	90	92	97	74	76	73	98	77
220.2	108	99	91	92	96	75	76	73	98	77
240.2	108	98	91	93	96	76	77	73	98	77
260.2	108	98	90	93	96	80	78	73	97	77
280.2	109	99	89	93	96	83	80	74	98	77
320.2	109	99	89	93	96	83	80	74	98	77
340.2	110	100	91	95	98	85	82	76	99	78
360.2	110	100	92	96	98	86	82	76	100	79
400.2	110	100	94	94	100	84	81	75	101	80
440.2	111	101	92	101	102	84	82	77	104	82
500.2	111	101	91	94	103	88	83	76	104	82
540.2	112	102	95	93	105	86	84	77	105	83
580.2	112	102	92	96	104	88	84	77	105	83

Sound levels refer to full load units, in test nominal conditions. The sound pressure level refers to 1 m. from the standard unit outer surface operating in open field. Measures according to UNI EN ISO 9614-2 regulations, with respect to the EUROVENT 8/1 certification. Data referred to the following conditions.

internal exchanger water = 12/7 °C Ambient temperature = 35 °C

EXCELLENCE VERSION

Acoustic configuration: super-silenced (EN)

General technical data - Construction

Size		200.2	210.2	220.2	240.2	260.2	280.2	320.2	340.2	360.2	400.2	440.2	500.2
Compressor													
Type of compressors	1	-	DSW	DSW	DSW	DSW	DSW	DSW	DSW	DSW	DSW	DSW	DSW
No. of compressors		No	2	2	2	2	2	2	2	2	2	2	2
Rated power (C1)		[HP]	100	100	110	120	120	140	160	160	180	200	250
Nominal capacity (C2)		[HP]	100	110	110	120	140	140	160	180	180	200	250
Std Capacity control steps		-	STEPLESS	STEPLESS	STEPLESS	STEPLESS	STEPLESS	STEPLESS	STEPLESS	STEPLESS	STEPLESS	STEPLESS	STEPLESS
Oil charge (C1)		[l]	17	17	17	17	17	21	21	21	25	25	25
Oil charge (C2)		[l]	17	17	17	17	21	21	21	25	25	25	25
Refrigerant charge (C1)		[kg]	66	66	77	80	91	106	118	118	119	133	159
Refrigerant charge (C2)		[kg]	66	66	77	80	92	113	124	125	125	139	168
Refrigeration circuits		-	2	2	2	2	2	2	2	2	2	2	2
Internal exchanger													
Type of internal exchanger	2	-	S&T	S&T	S&T	S&T	S&T	S&T	S&T	S&T	S&T	S&T	S&T
N. of internal exchanger		No	1	1	1	1	1	1	1	1	1	1	1
Water content		[l]	255	255	307	307	307	280	280	280	280	481	514
External exchanger													
Frontal surface		m ²	18.7	18.7	23.4	23.4	23.4	28.1	28.1	32.8	32.8	37.4	46.8
External Section Fans													
Type of fans	3	-	AX	AX	AX	AX	AX	AX	AX	AX	AX	AX	AX
Number of fans		Nr	10	10	10	12	12	14	16	16	16	20	20
Type of motor	4	-	EC	EC	EC	EC	EC	EC	EC	EC	EC	EC	EC
Standard airflow		[l/s]	39696	39484	39272	47636	46210	54981	62835	61613	60392	79392	75490
Connections													
Water fittings		-	6"	6"	6"	6"	6"	6"	8"	8"	8"	8"	10"
Power supply													
Standard power supply		V	400/3~/50	400/3~/50	400/3~/50	400/3~/50	400/3~/50	400/3~/50	400/3~/50	400/3~/50	400/3~/50	400/3~/50	400/3~/50
Electrical data													
FLA Total		A	359	377	396	426	474	528	586	626	666	730	879
FLI Total		kW	221	233	244	263	287	315	349	373	397	435	531
M.I.C. - Value	5	A	351	404	417	429	425	464	552	646	676	702	937
M.I.C. - with soft start accessory	5	A	511	592	606	623	608	647	779	967	997	1024	1361

1. DSW = double screw compressor

2. S&T = shell and tube

3. AX = axial fan

4. EC = electronic permanent-magnet switching motor without brushes with speed automatic control

Unbalance between phase max 2 %

Voltage variation: max +/- 10%

Electrical data refer to standard units; according to the installed accessories, the data can suffer some variations.

5. M.I.C. = compressor 2 starting current + compressor 1 current at 75% of the max load + circuit 1 fan

Sound levels

Size	Sound power level (dB)								Sound power level dB(A)	Sound pressure level dB(A)
	Octave band (Hz)									
	63	125	250	500	1000	2000	4000	8000		
200.2	96	90	81	89	93	68	66	61	94	73
210.2	96	90	85	88	93	69	66	61	94	73
220.2	96	90	88	88	93	70	66	61	94	73
240.2	97	91	87	90	93	71	68	62	94	73
260.2	97	90	86	89	93	77	72	63	94	73
280.2	98	89	85	90	92	80	74	64	94	72
320.2	99	90	85	90	93	80	75	65	94	73
340.2	99	90	87	91	94	81	76	65	95	74
360.2	99	90	88	92	95	82	76	65	96	74
400.2	100	92	91	91	97	81	76	66	98	76
440.2	100	92	88	98	99	81	75	66	100	78
500.2	100	92	87	90	100	84	78	66	100	78

Sound levels refer to full load units, in test nominal conditions. The sound pressure level refers to 1 m. from the standard unit outer surface operating in open field. Measures according to UNI EN ISO 9614-2 regulations, with respect to the EUROVENT 8/1 certification. Data referred to the following conditions.

internal exchanger water = 12/7 °C Ambient temperature = 35 °C

PREMIUM VERSION

Acoustic configuration: super-silenced (EN)

General technical data - Construction

Size		200.2	210.2	220.2	240.2	260.2	280.2	320.2	340.2	360.2	400.2	440.2	500.2	540.2	580.2	
Compressor																
Type of compressors	1	-	DSW	DSW	DSW	DSW	DSW	DSW	DSW	DSW	DSW	DSW	DSW	DSW	DSW	DSW
No. of compressors		No	2	2	2	2	2	2	2	2	2	2	2	2	2	2
Rated power (C1)		[HP]	100	100	110	120	120	140	160	160	180	200	220	250	270	290
Nominal capacity (C2)		[HP]	100	110	110	120	140	140	160	180	180	200	220	250	270	290
Std Capacity control steps		-	STEPLESS	STEPLESS	STEPLESS	STEPLESS	STEPLESS	STEPLESS	STEPLESS	STEPLESS	STEPLESS	STEPLESS	STEPLESS	STEPLESS	STEPLESS	STEPLESS
Oil charge (C1)		[l]	17	17	17	17	17	21	21	21	25	25	25	25	30	30
Oil charge (C2)		[l]	17	17	17	17	21	21	21	25	25	25	25	25	30	30
Refrigerant charge (C1)		[kg]	63	63	70	73	67	81	93	93	108	108	126	138	160	161
Refrigerant charge (C2)		[kg]	60	67	67	70	77	81	93	98	114	114	135	147	169	170
Refrigeration circuits		-	2	2	2	2	2	2	2	2	2	2	2	2	2	2
Internal exchanger																
Type of internal exchanger	2	-	S&T	S&T	S&T	S&T	S&T	S&T	S&T	S&T	S&T	S&T	S&T	S&T	S&T	S&T
N. of internal exchanger		No	1	1	1	1	1	1	1	1	1	1	1	1	1	1
Water content		[l]	238	238	238	233	255	280	280	280	280	280	481	481	514	514
External exchanger																
Frontal surface		m ²	18.7	18.7	18.7	18.7	23.4	23.4	28.1	28.1	32.8	32.8	37.4	46.8	46.8	46.8
External Section Fans																
Type of fans	3	-	AX	AX	AX	AX	AX	AX	AX	AX	AX	AX	AX	AX	AX	AX
Number of fans		No	8	8	8	8	10	10	12	12	14	14	16	20	20	20
Type of motor	4	-	EC	EC	EC	EC	EC	EC	EC	EC	EC	EC	EC	EC	EC	EC
Standard airflow		[l/s]	32000	32000	30000	30000	39000	38000	47000	45000	55000	53000	60000	79000	78000	75000
Connections																
Water fittings		-	8"	8"	8"	8"	6"	6"	6"	6"	6"	6"	8"	8"	8"	8"
Power supply																
Standard power supply		V	400/3~/50	400/3~/50	400/3~/50	400/3~/50	400/3~/50	400/3~/50	400/3~/50	400/3~/50	400/3~/50	400/3~/50	400/3~/50	400/3~/50	400/3~/50	400/3~/50
Electrical data																
FLA Total		A	355	373	391	417	470	519	577	617	661	717	789	879	945	1010
FLI Total		kW	219	230	242	258	285	310	344	368	395	428	482	531	579	619
M.I.C. - Value	5	A	348	401	415	425	423	460	548	642	674	695	794	937	1077	1234
M.I.C. - with soft start accessory	5	A	509	590	604	619	606	643	775	963	995	1017	1153	1361	1650	1834

- DSW = double screw compressor
- S&T = shell and tube
- AX = axial fan
- EC = electronic permanent-magnet switching motor without brushes with speed automatic control

Unbalance between phase max 2 % Voltage variation: max +/- 10%
 Electrical data refer to standard units; according to the installed accessories, the data can suffer some variations.
 5. M.I.C. = compressor 2 starting current + compressor 1 current at 75% of the max load + circuit 1 fan

Sound levels

Size	Sound power level (dB)								Sound power level dB(A)	Sound pressure level dB(A)
	Octave band (Hz)									
	63	125	250	500	1000	2000	4000	8000		
200.2	95	90	82	89	93	69	66	61	94	74
210.2	95	90	86	89	93	70	66	61	94	74
220.2	95	91	88	88	93	71	66	60	94	74
240.2	95	91	87	90	93	72	67	61	94	74
260.2	97	90	87	90	93	78	72	63	94	74
280.2	97	89	85	90	93	80	75	63	94	73
320.2	98	89	86	90	93	80	75	64	95	74
340.2	98	90	87	91	94	82	76	64	96	75
360.2	99	91	89	93	96	83	77	65	97	75
400.2	99	91	91	91	98	81	75	65	98	77
440.2	100	92	88	98	99	81	75	66	101	79
500.2	101	93	88	91	101	85	79	67	101	79
540.2	101	93	92	90	102	83	79	67	102	80
580.2	101	94	88	93	102	86	79	67	102	80

Sound levels refer to full load units, in test nominal conditions. The sound pressure level refers to 1 m. from the standard unit outer surface operating in open field. Measures according to UNI EN ISO 9614-2 regulations, with respect to the EUROVENT 8/1 certification. Data referred to the following conditions.

internal exchanger water = 12/7 °C Ambient temperature = 35 °C

Operating range

EXCELLENCE VERSION

Acoustic configuration: standard (ST) / Compressor soundproofing (SC)

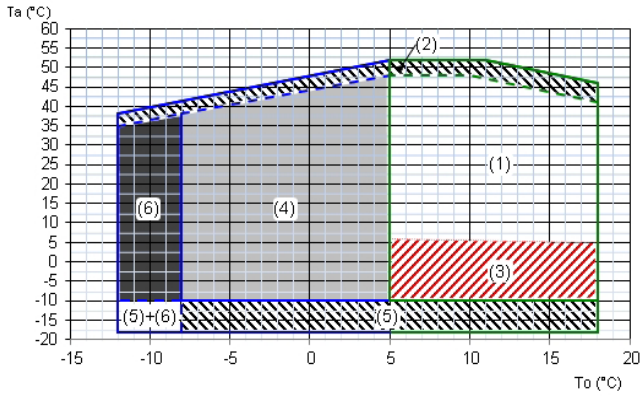

Ta (°C) = external exchanger inlet air temperature (D.B.)
To (°C) = internal exchanger outlet water temperature

1. Standard unit operating range at full load
2. Unit operating range with automatic staging of the compressor capacity
3. Standard unit operating range with air flow automatic modulation
4. Unit operating range in 'B - Low water temperature' configuration (40% ethylene glycol)
5. Unit operating range with 'REGBT - device for the condensing coil partialization'
6. Extended of operating range (extremely low water temperature option available on request)

Acoustic configuration: super-silenced (EN)

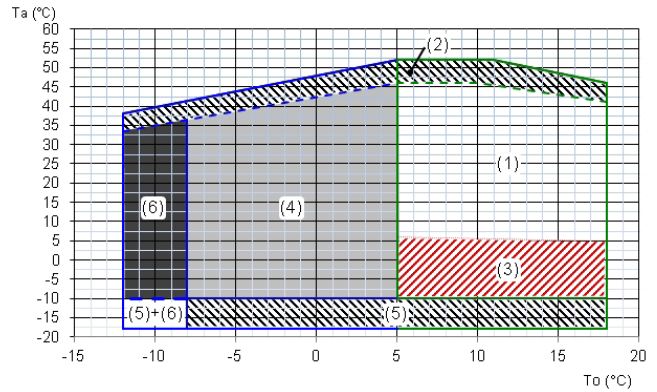

Ta (°C) = external exchanger inlet air temperature (D.B.)
To (°C) = internal exchanger outlet water temperature

1. Standard unit operating range at full load
2. Unit operating range with automatic staging of the compressor capacity
3. Standard unit operating range with air flow automatic modulation
4. Unit operating range in 'B - Low water temperature' configuration (40% ethylene glycol)
5. Unit operating range with 'REGBT - device for the condensing coil partialization'
6. Extended of operating range (extremely low water temperature option available on request)

PREMIUM VERSION

Acoustic configuration: standard (ST) / Compressor soundproofing (SC)

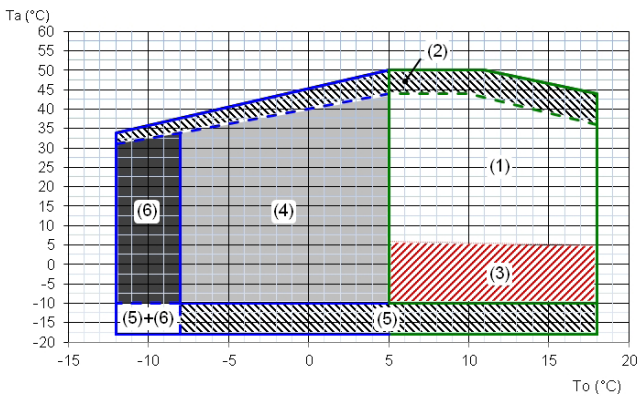

Ta (°C) = external exchanger inlet air temperature (D.B.)
To (°C) = internal exchanger outlet water temperature

1. Standard unit operating range at full load
2. Unit operating range with automatic staging of the compressor capacity
3. Standard unit operating range with air flow automatic modulation
4. Unit operating range in 'B - Low water temperature' configuration (40% ethylene glycol)
5. Unit operating range with 'REGBT - device for the condensing coil partialization'
6. Extended of operating range (extremely low water temperature option available on request)

Acoustic configuration: super-silenced (EN)

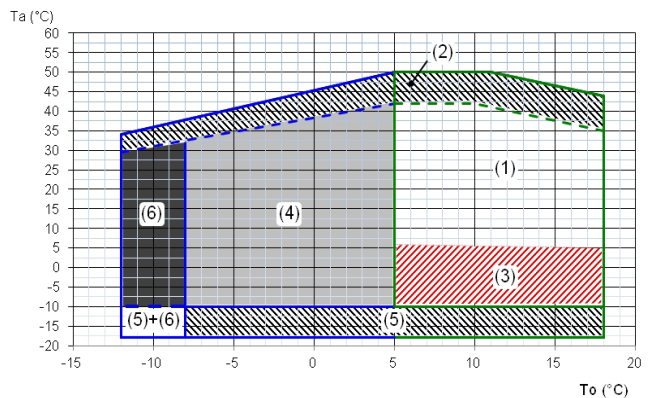

Ta (°C) = external exchanger inlet air temperature (D.B.)
To (°C) = internal exchanger outlet water temperature

1. Standard unit operating range at full load
2. Unit operating range with automatic staging of the compressor capacity
3. Standard unit operating range with air flow automatic modulation
4. Unit operating range in 'B - Low water temperature' configuration (40% ethylene glycol)
5. Unit operating range with 'REGBT - device for the condensing coil partialization'
6. Extended of operating range (extremely low water temperature option available on request)

Unit equipment with outdoor air low temperatures

Minimum outdoor air temperature		Operating unit	Unit in stand-by ⁽⁵⁾ (fed unit)	Unit in storage (unit not fed)
+11°C	1	✓ standard unit ✗ not suitable: fans with ON-OFF control (optional)	✓ standard unit	
+2°C	2			
-7°C	3			
-10°C	4			
Between -10°C and -18°C		✓ unit in acoustic configuration: compressor soundproofing (SC) or super-silenced (EN) ✓ electrical panel antifreeze protection ✓ glycol in an appropriate percentage ✓ device for the condensing coil partialization ✗ not suitable: fans with ON-OFF control (optional)	✓ electrical panel antifreeze protection ✓ glycol in an appropriate percentage	✓ standard unit ⁽⁶⁾
Between -18°C and -25°C		NOT POSSIBLE	✓ water empty unit ✓ electrical panel antifreeze protection	✓ water empty unit ✗ not suitable: built-in pumps
Between -25°C and -39°C			✗ not suitable: built-in pumps	NOT POSSIBLE

OPT = accessory

Data referred to the following conditions:

internal exchanger water = 12/7°C

1. Part load unit and air speed equal to 1 m/s.
2. Part load unit and air speed equal to 0.5 m/s.
3. Part load unit and outdoor air temperature at rest.
4. Unit at full load and outdoor air temperature at rest.

⁽⁵⁾ The water pumping unit must be fed and connected to the unit according to the manual.

⁽⁶⁾ Unit without water or containing water with an appropriate quantity of glycol.

At the unit start-up the water temperature or water with glycol must be inside the operating range indicated in the "Operating range" graph.

To know the water freezing temperature on varying the glycol percentage refer to the specific 'Correction factors for glycol use' table.



Air conditions which are at rest are defined as the absence of air flowing towards the unit. Weak winds can induce air to flow through the exchanger and air-levels which can cause a reduction in the operating range. In the presence of predominant winds it is necessary to use suitable windbreak barriers.

Minimum system water content

For a proper functioning of the unit a minimum water content has to be provided to the system, using the formula:

$$\begin{aligned} \text{Minimum water content [l]} &= 7 \times \text{kWf (air conditioning application)} \\ &= 14 \times \text{kWf (application with low outdoor temperature or low loads required)} \end{aligned}$$

kWf = Nominal cooling capacity unit



Volume calculated does not consider internal heat exchanger (evaporator) water content.

Admissible water flow-rates

Minimum (Qmin) and maximum (Qmax) admissible water flow for the unit to operate correctly.

EXCELLENCE ST/SC		200.2	210.2	220.2	240.2	260.2	280.2	320.2	340.2	360.2	400.2	440.2	500.2	540.2	580.2
Qmin	[l/s]	15.3	15.3	20.1	20.1	20.1	21.6	21.6	21.6	21.6	39.4	39.4	32.3	32.3	32.3
Qmax	[l/s]	37.3	37.3	45.2	45.2	45.2	53.4	53.4	53.4	53.4	86.6	86.6	72.5	72.5	72.5

PREMIUM ST/SC		200.2	210.2	220.2	240.2	260.2	280.2	320.2	340.2	360.2	400.2	440.2	500.2	540.2	580.2
Qmin	[l/s]	17.7	17.7	17.7	16.7	16.7	20.1	20.1	20.1	21.6	21.6	39.4	39.4	32.3	32.3
Qmax	[l/s]	37.7	37.7	37.7	37.2	37.2	45.2	45.2	45.2	53.4	53.4	86.6	86.6	72.5	72.5

EXCELLENCE EN		200.2	210.2	220.2	240.2	260.2	280.2	320.2	340.2	360.2	400.2	440.2	500.2
Qmin	[l/s]	17.5	17.5	20.1	20.1	20.1	21.6	21.6	21.6	21.6	39.4	39.4	32.3
Qmax	[l/s]	37.9	37.9	45.2	45.2	45.2	53.4	53.4	53.4	53.4	86.6	86.6	72.5

PREMIUM EN		200.2	210.2	220.2	240.2	260.2	280.2	320.2	340.2	360.2	400.2	440.2	500.2	540.2	580.2
Qmin	[l/s]	17.7	17.7	17.7	16.7	17.5	20.1	20.1	20.1	21.6	21.6	39.4	39.4	32.3	32.3
Qmax	[l/s]	37.7	37.7	37.7	37.2	39.2	45.2	45.2	45.2	53.4	53.4	86.6	86.6	72.5	72.5

Correction factors for glycol use

% ethylene glycol by weight		5%	10%	15%	20%	25%	30%	35%	40%
Freezing temperature	°C	-2,0	-3,9	-6,5	-8,9	-11,8	-15,6	-19,0	-23,4
Safety temperature	°C	3,0	1,0	-1,0	-4,0	-6,0	-10,0	-14,0	-19,0
Cooling Capacity Factor	No	0,995	0,989	0,983	0,977	0,971	0,964	0,956	0,949
Compressor power input Factor	No	1,0011	1,0022	1,003	1,004	1,006	1,007	1,008	1,009
Internal exchanger glycol solution flow factor	No	1,003	1,01	1,02	1,033	1,05	1,072	1,095	1,124
Pressure drop Factor	No	1,05	1,10	1,15	1,20	1,25	1,30	1,35	1,40

Fouling Correction Factors

m ² °C / W	Internal exchanger (evaporator)	
	F1	FK1
0.44 x 10⁻⁴	1,0	1,0
0.88 x 10⁻⁴	0,97	0,99
1.76 x 10⁻⁴	0,94	0,98

F1 = Cooling capacity correction factors

FK1 = Compressor power input correction factor

Exchanger operating range

PED (CE)	Internal exchanger	
	DPr	DPw
	2450	1050

DPr = Maximum operating pressure on refrigerant side in kPa

DPw = Maximum operating pressure on water side in kPa

Overload and control device calibrations

		open	closed	value
High pressure switch	[kPa]	2100	1550	–
Antifreeze protection	[°C]	3	5.5	–
High pressure safety valve	[kPa]	–	–	2500
Low pressure safety valve	[kPa]	–	–	1650
Max no. of compressor starts per hour	[n°]	–	–	6
Discharge safety thermostat	[°C]	–	–	120

Standard unit technical specifications

Compressor

Compact, semi hermetic, helicoidal twin-screw compressors: the main screw (male, with five lobes) is driven directly by the electric motor, while the secondary screw (female with six vanes) is driven by the primary one. Continuous modulation of the delivered cooling capacity, with no-load starting. Leak tightness is guaranteed by the extremely accurate tolerances in processing all the moving parts and by specific oil circulation between the screws. Lubrication system with free circulation resulting from pressure differences, equipped with high efficiency separator, oil level indicator and filter (replaceable). Resistance heater for oil heating to prevent excessive dilution by the refrigerant, automatically activated whenever the compressor is off. Two-pole, three-phase, asynchronous electric motor cooled by the sucked-in gas, with Star/Delta reduced-load starting. Fully protected electronic module, with safety sensor for monitoring discharge temperature, sensors for monitoring maximum temperature of the windings, device to control the motor rotation direction and device to monitor absence of phase. Cut-off valve on the discharge line of the refrigerant. Filter on the supply line, at the compressor inlet. Built-in attenuator and non-return valve on the compressor's drain. Automatic safety valve inside the compressor between the high pressure (HP) and low pressure (LP) areas.

Internal exchanger (evaporator)

Direct expansion exchanger with refrigerant side independent circuit for each compressor. The exchanger is composed of a cover made of carbon steel. The tubes, anchored to the tube plate by mechanical expansion, are made of copper, high efficiency, internally rifled to improve thermal exchange and specially designed for use with modern ecological refrigerants. It is also complete with protection differential pressure switch and with a coating made of closed-cell heat insulating material to prevent condensate formation and heat exchange with the outside. The water connections of the exchanger are quick-release with splined joint.

External exchanger (condenser)

Finned exchanger, made of copper pipes arranged in staggered rows and mechanically expanded to adhere better to the fin collar. The exchangers are planned, designed and produced directly by CLIVET. The fins are made of aluminium with a special corrugated surface, with a suitable distance apart to ensure a maximum heat exchange efficiency. The coils are complete with integral subcooling circuit which assures the correct refrigerant feeding of the expansion valve.

Fan

Axial fans with sickle profile blades terminating with "Winglets", directly coupled to the three-phase electronic controlled motor with external rotor. Fans are housed in aerodynamically shaped structures, equipped with accident prevention guards and supplied with variable speed electronic control. Complete with Axitop diffusers to recover dynamic energy, resulting in increased efficiency and minimal sound emission.

Refrigeration circuit

The units are made with two independent refrigeration circuits, each with:

- circuit with economizer exchanger
- electronic expansion valve
- safety high pressure switch
- low pressure safety valve (safety valve with shut-off valve sealed with lead, open for possible inspection)
- high pressure safety valve (safety valve with shut-off valve sealed with lead, open for possible inspection)
- high and low pressure gauges
- replaceable anti-acid solid cartridge dehydrator filter with connection for refrigerant quick charge
- liquid flow and moisture indicator
- cutoff valve on compressor supply
- cutoff valve on liquid line

Electrical panel

The capacity section includes:

- main door lock isolator switch (compulsory to have CE certification)
- isolating transformer for auxiliary circuit power supply
- fan overload circuit breakers
- fuses and thermal relays to protect the compressors
- compressor control contactor
- electrical panel ventilation

The control section includes:

- proportional-integral-derivative (PID) control of water temperature
- antifreeze protection
- unit switching on management by local or remote (serial)
- compressor overload protection and timer
- potential-free contacts for compressor status and enabling
- self-diagnosis system with immediate display of the fault code
- prealarm function for water antifreeze and high refrigerant gas pressure
- compressor operating hour display
- multifunction phase monitor
- remote ON/OFF control
- second set-point enabling by potential-free contact
- automatic rotation control for compressor starts
- relay for remote cumulative fault signal
- display of the set values, the error codes and the parameter index
- high refrigerant gas pressure pre-alarm function that in many cases prevents the unit from being shut-down
- inlet for demand limit (power input limitation according to a 0÷10V or 4÷20 mA external signal)
- interface terminal with graphic display

Accessories

- Spring antivibration mounts (separately supplied accessories)
- Couple of manually operated shut-off valves (separately supplied accessories)
- Progressive compressor start-up device
- Compressor magnetothermic circuit breakers
- Device for the condensing coil partialization
- Device for consumption reduction of the external section Ecobreeze fans
- Device to reduce the consumption levels of on/off fans on the external section
- Power factor correction capacitors (cosfi > 0.9)
- Energy meter
- Set-point compensation with outdoor air temperature probe
- Set-point compensation with 0-10 V signal
- Set-point compensation with 4-20mA signal
- Serial communication module for BACnet-IP supervisor
- Serial communication module for LonWorks supervisor
- Serial communication module for Modbus supervisor
- Remote control via microprocessor remote control (separately supplied accessories)
- Mains power supply unit (separately supplied accessories)
- ECOSHARE function for the automatic management of a group of units
- Electrical panel antifreeze protection
- Condensing coil protection grilles and technical compartment
- Condensing coil anti-hail protection grilles
- Copper / aluminium condensing coil with acrylic lining
- Copper / aluminium condensing coil with Aluminium Energy Guard DCC treatment

On request are available:

- Copper / copper condensing coil

Test

All the units are factory-tested in specific steps, before shipping them. After the approval, the moisture contents present in all circuits are analyzed, in order to ensure the respect of the limits set by the manufacturers of the different components.

Configurations

SC - Acoustic configuration with compressor soundproofing

Configuration used to increase the unit's silent operation by acting on the source of the noise. It consists of suitable steel casings lined with high-density material designed to provide sound insulation. The casings are secured to an aluminium frame and painted on the outside with polyester powder (RAL 9001).



To assess the quality of the soundproofing benefit, refer to the 'Sound levels' tables.

EN - Super-silenced configuration

Configuration used to increase the unit's silent operation by acting on the source of the noise. It consists of suitable steel casings lined with high-density material designed to provide sound insulation. The casings are secured to an aluminium frame and painted on the outside with polyester powder (RAL 9001).

Fans at low RPM.



To assess the quality of the soundproofing benefit, refer to the 'Sound levels' tables.

B - Water low temperature (Brine)

Configuration also known as "Brine". Enables an "unfreezable" solution to be cooled (for example, water and ethylene glycol in suitable quantities) up to a temperature of between +4°C and -8°C. It includes:

- suitable exchangers with extra-thick closed-cell insulation
- electronic expansion valve, functional calibration and safety devices suitable for particular uses.



During the selection phase it is necessary to indicate the required operating type, the unit will be optimised on the basis of this: - Unit with single operating set-point (only at low temperature) - Unit with double operating set-point.



The unit in this configuration has a different operating field, which was reported in the previous pages.



In low temperature operation, some staging steps could not be available.



The glycol concentration must be chosen based on the minimum temperature the water can reach. The presence of glycol influences pressure drops on the water side and the unit's output as indicated in the table reporting the "correction factors for use with glycol".



The "Extremely low water temperature" option for the chilled water production down to -12°C is available on request.

Correction factor for water low temperature

Evaporator outlet water temperature factor	2	0	-2	-4
Cooling capacity factor	0.860	0.804	0.748	0.692
Compressor power input factor	0.945	0.923	0.901	0.879



The correction coefficients must be applied to condition: internal exchanger water (evaporator) = 12 / 7 °C.

Example: Determine the performance with leaving water temperature -4°C for WDAT-SL3 200.2 EXC ST B (Excellence' version, 'Water low temperature' configuration) with external exchanger water (condenser) 35°C, 30% glycol.

From the performance table referred to entering external exchanger water temperature (condenser) 35 °C and leaving internal exchanger water temperature (evaporator) 7°C:

Cooling capacity = 486 kW, Compressor power input = 141 kW

From the correction factor table for water low temperature: 0.692 for cooling capacity and 0.879 for compressor power input (supply water temperature -4°C)

From the glycol correction factor: 0.964 for cooling capacity, 1.007 for compressor power input, 1.072 the glycol solution flow, 1.3 for the evaporator pressure drop (glycol 30%)

Calculation WDAT-SL3 200.2 EXC ST B: Cooling capacity = 486 x 0.692 x 0.964 = 324.2 kW, Compressor power input = 141 x 0.879 x 1.007 = 124.8 kW

Water flow-rate = 15.5 (calculated on 324.2 kW) x 1.072 = 16.6 l/s, Evaporator pressure drop = 21 (calculated on 15.5 l/s) x 1.3 = 27.3 kPa

D - Partial energy recovery

A configuration which enables the production of hot water free-of-charge while operating in the cooling mode, thanks to the partial recovery of condensation heat that would otherwise be rejected to the external heat source. This option is also called 'desuperheater'. It consists of shell and tube heat exchangers, suitable to recover part of the unit heating capacity (equal to the sum of the cooling capacity and the capacity absorbed by the compressors).

The partial recovery device is considered to be operating when it is powered by the water flow which is to be heated. This condition improves the unit performance, since it reduces the condensation temperature: in nominal conditions the cooling capacity increases indicatively by 3.2% and the power input of the compressors is reduced by 3.6%.

When the temperature of the water to be heated is particularly low, it is wise to insert a flow control valve into the system water circuit, in order to maintain the temperature at the recovery output at above 35°C and thus avoid the condensation of the refrigerant into the partial energy recovery device.

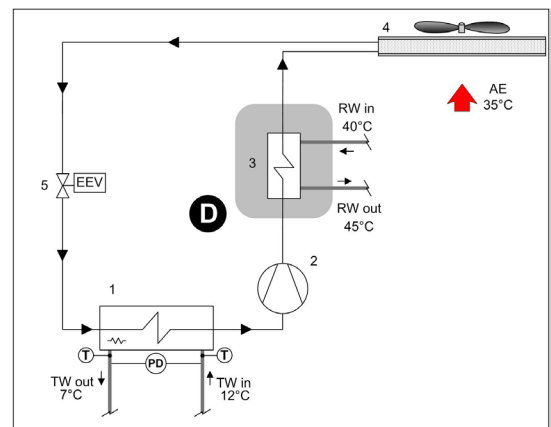

D - Partial recovery device

TW in chilled water inlet
TW out chilled water outlet

- 1 - Internal exchanger
- 2 - Compressors
- 3 - Recovery exchanger
- 4 - External exchanger
- 5 - Expansion electronic valve

RW in - Recovery water inlet
RW out - Recovery water outlet

T - Temperature probe
PD - Differential pressure switch
AE Outdoor air



The maximum capacity available from the partial recovery is equal to the 15% of the rejected heating capacity (cooling capacity + compressor power input)

Pressure drops of partial energy recovery exchanger

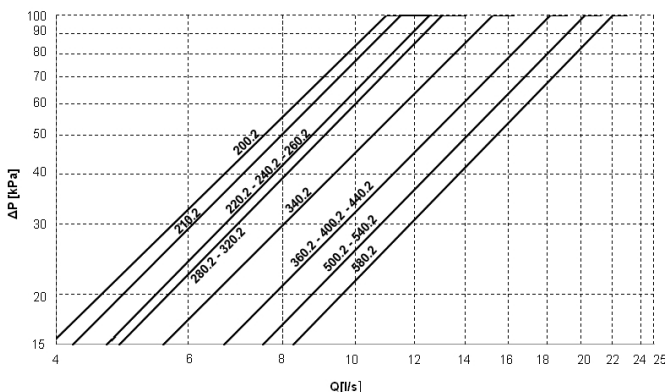

Q = water flow-rate [l/s]
DP = water side pressure drops (kPa)

Example: Required cooling capacity: 500 kW at 12/7°C chilled water and 35°C outdoor air.

Size purpose of the study: WDAT-SL3 210.2 EXC ST

Hot water required temperature: +45°C

Recovery capacity: 19% di 500 kW = 95 kW

Design flow-rate: 4,5 l/s

Partial recovery heating capacity

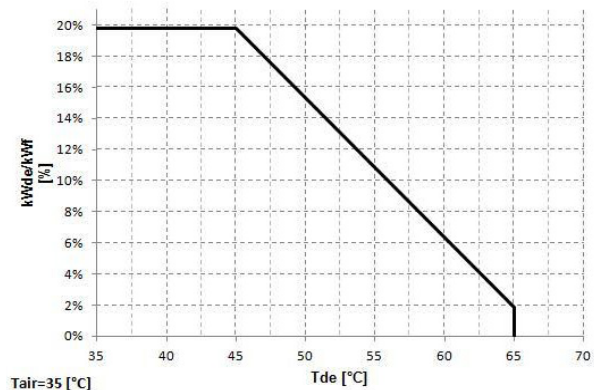

kWde/kWf = Heat recovered/Cooling capacity [%]
Tde = Heat recovering device outlet water temperature [°C]



Data refer to outdoor air conditions T=35°C

R - Total energy recovery

A configuration that allows the free production of hot water when operating in cooling mode, thanks to the total recovery of the condensation heat that would otherwise be rejected to the external thermal source. This solution increases the system's overall efficiency in all cases where enhanced hot water production is required. It consists of shell and tube heat exchangers, suitable to recover all the unit heat capacity (equal to the sum of the cooling capacity and electrical capacity absorbed by the compressors), from the on-off solenoid valves, the temperature sensors on the supply and return of the hot water circuit and from the relative built-in control logic at two staging steps. Hot water availability is always subordinate to the production of chilled water. See the following example:

1. cooling capacity request = 100% / Heating capacity request = 0% >Production only of cooling capacity;
2. cooling capacity request = 100% / Heating capacity request = 0% >Production of cooling and heating capacity by recovery;
3. cooling capacity request = 50% / Heating capacity request = 100% >Production of cooling and heating capacity by recovery, equal to the 50% of the requested heating capacity.



To prevent constant switching in the unit's refrigeration circuit, it is necessary to install a storage tank with an adequate capacity in the system's hot water circuit.



In the absence of hot water circulation in the recovery exchanger, the maximum inlet air temperature is reduced by approximately 2°C compared with the unit without "Total Energy Recovery" mode.

TOTAL OPERATING ENERGY RECOVERY

The pump on the recovery exchanger must be activated when hot water is required. Condensation takes place entirely in the recovery circuit.

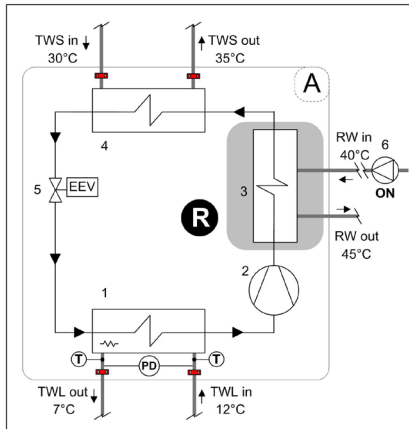

R - Total recovery device
A - Unit supply limit

- 1 - Internal exchanger (evaporator)
- 2 - Compressor
- 3 - Recovery exchanger
- 4 - External exchanger (condenser)

5 - Expansion electronic valve
6 - Pump recovery side (supply and management provided by the Customer)

TWS in - Water inlet source side
TWS out - Water outlet source side
TWL in - Water inlet user side

TOTAL NON-OPERATING ENERGY RECOVERY

When the recovery is achieved, the pump on the recovery side must be disabled.

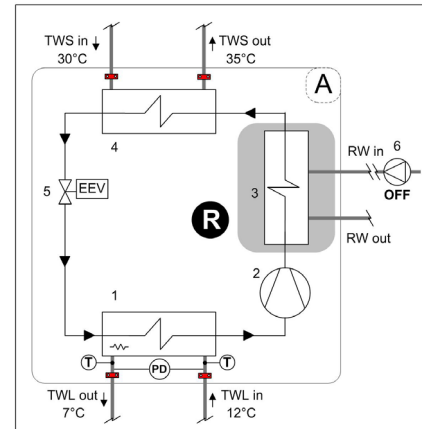

TWL out - Water output user side
RW in - Recovery water inlet
RW out - Recovery water outlet
T - Temperature probe
PD - Differential pressure switch

Pressure drops of the total energy recovery exchanger

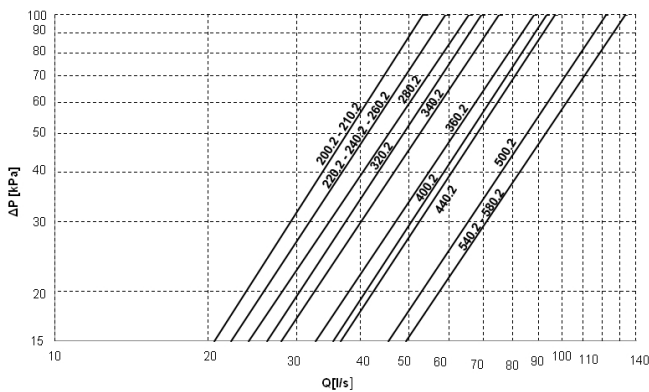

Q = water flow-rate [l/s]
DP = pressure drop water side (kPa)

Operating range with recovery

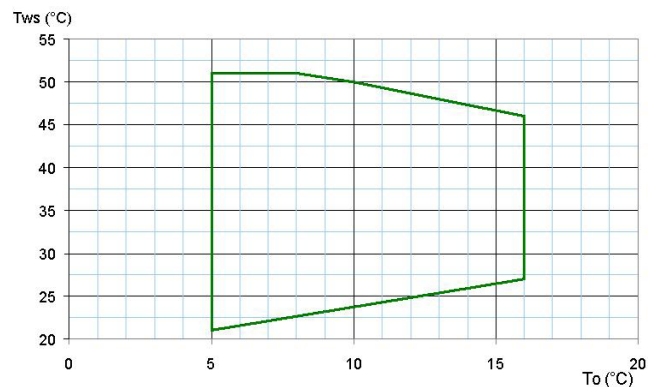

To = leaving internal exchanger water temperature (evaporator)
Tws = leaving recovery exchanger water temperature

Application of the partial / total energy recovery

In almost all systems fitted with a chiller used to produce chilled water there is also the need to have hot water. The recovery of condensation heat is an efficient way of producing hot water while the chiller is in operation. It has the double benefit of both reducing the heat load to the condenser, thereby eliminating dissipation costs and generating free hot water, thereby reducing the costs of the auxiliary heater.

Application versatility of recovery devices

The hot water produced by heat recovery can be used in a number of ways: to reheat air in handling units, to preheat hot water for domestic use or industrial processes, to heat up water in swimming pools, showers and spas, to preheat hot water for laundries or industrial kitchens.



Post-heating in air handling units to control humidity levels in hospitals and labs



Preheating of hot water for domestic use or for industrial process



Heating of water in swimming pools, showers and SPAS



Preheating of hot water for laundries and industrial kitchens

Water heating up

The heat recovery device can be used to cover the entire heat load required. The hot water supply temperature is controlled via a modulating control valve that needs to be fitted on the system at the outlet of the recovery unit. The auxiliary heating device is recommended to cover the thermal energy demand when the chiller is not in operation or is operating at part load.

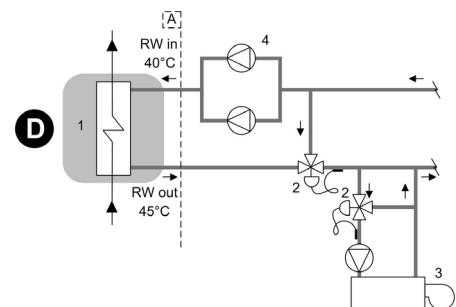

Example of how heat recovery is used to cover the entire heat demand and control the operating temperature

Water preheating

The heat recovery device can be used to preheat water at the inlet of the main heating device (e.g. boiler). In this case, the demand for hot water is greater than the amount of heat recovered by condensation and the recovery device only covers part of the required heat load. By preheating the water, heating consumption levels are therefore reduced and the main heating device has a lower installed power requirement.

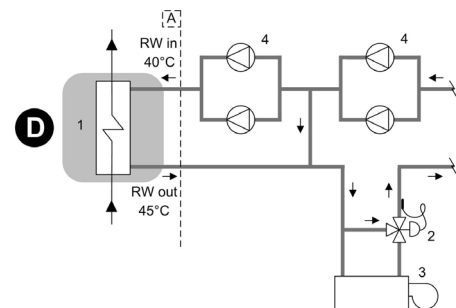

Example of how heat recovery is used to preheat hot water in the system

Domestic hot water production

The heat recovery device can be used to produce water for domestic use. In order to prevent contamination of domestic water with the chiller's process fluid, it is necessary to insert an intermediate heat exchanger. Using an inertial heat storage tank allows to have a reserve of preheated water and enables the intermediate exchanger to operate more efficiently.

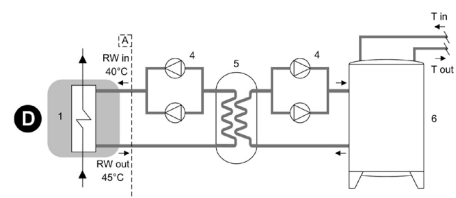

Example of how heat recovery is used to preheat hot water for domestic use

- A - Unit supply limit
- 1 - Recovery exchanger
- 3 - Auxiliary heating device (ex.boiler)
- 5 - Intermediate heat exchanger
- RW in - Recovery water inlet
- T in - Drinkable water inlet

- D - Partial energy recovery
- 2 - Control modulating valve
- 4 - Electric pump with standby pump
- 6 - Inertial heat storage
- RW out - Recovery water outlet
- T out - Drinkable water outlet to the auxiliary heater

The diagrams refer to partial energy recovery, though they also apply to total energy recovery (Clivet R). Please note that the diagrams are only meant as a guide.

Accessories - Hydronic assembly

2PM/3PM - HydroPack with no.2/3 pumps

Option supplied built-in the unit. Pumping unit made up of two or three electric pumps laid out in parallel, with auto-adaptive modular logic activation.

It enables the automatic reduction of the liquid flow-rate in critical conditions, avoiding blocks due to overloading and consequential intervention work by specialised technical personnel.

Centrifugal electric pump, with the pump body made of cast iron and the impeller made of AISI 316 stainless steel.

Mechanical seal using ceramic, carbon and EPDM elastomer components.

Three-phase electric motor with IP55 degree of protection. Complete with a thermoformed insulating casing, quick connections with insulated casing, non-return valve, safety valve, pressure gauges, system safety pressure switch, stainless steel antifreeze, intake, immersion-type heaters.

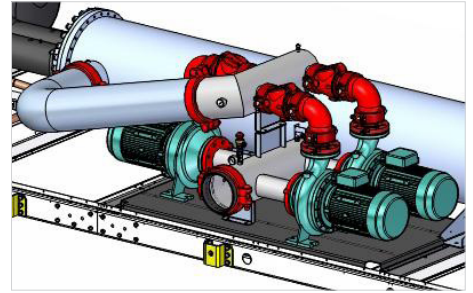

In order to increase the unit's silent operation, as an alternative to electric pumps with a 2-pole motor (2950 rpm), there are also electric pumps with 4-pole motors (1450 rpm), subject to a check regarding the maximum available pressure. The super-silent acoustic configuration (EN) only comes with electric pumps fitted with 4-pole motors.

CONNECTION DIAGRAM - GROUP WITH 2 PUMPS

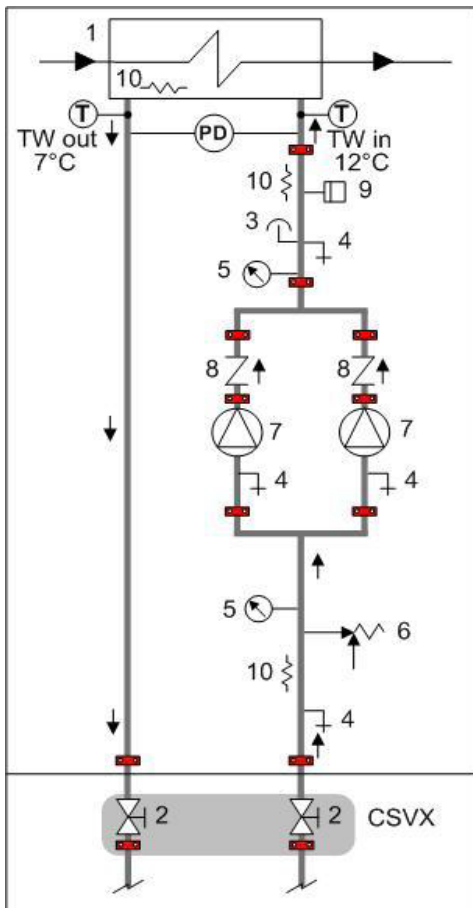

CONNECTION DIAGRAM - GROUP WITH 3 PUMPS

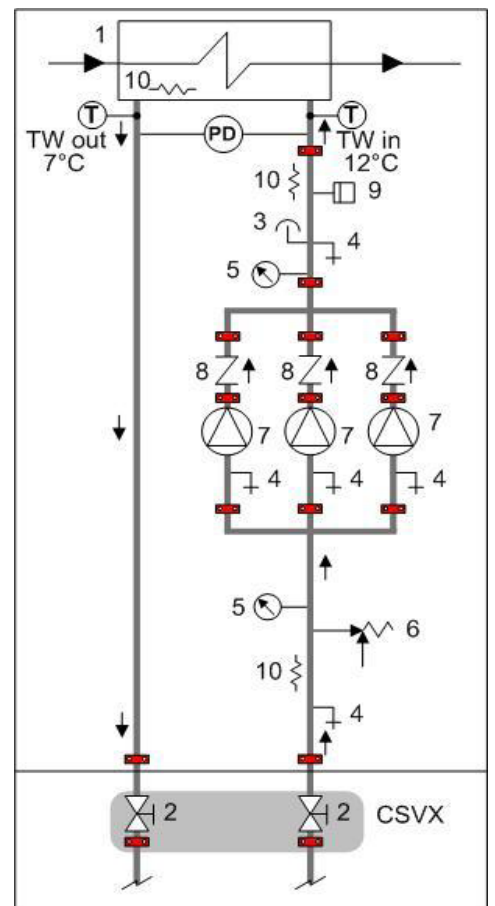

- 1 - Internal exchanger
- 2 - Cutoff valve
- 3 - Purge valve
- 4 - Discharge stop valve
- 5 - Pressure gauge
- 6 - Safety valve (6 Bar)
- 7 - Packaged electric pump with high efficiency impeller

- 8 - Non return valve
- 9 - System load safety pressure switch (it avoids the pump operation if water is not present)
- 10 - Antifreeze heater
- T - Temperature probe
- PD - Differential pressure switch

TW in chilled water inlet
TW out chilled water outlet

CSVX - Couple of manually operated shut-off valves

The grey area indicates further optional components.



Provide hydraulic interceptions outside the unit ('CSVX - Couple of manually operated shut-off valves' option) to facilitate any possible extraordinary maintenance interventions.

2PM / 3PM option performances (electric pump with 2-pole motor)

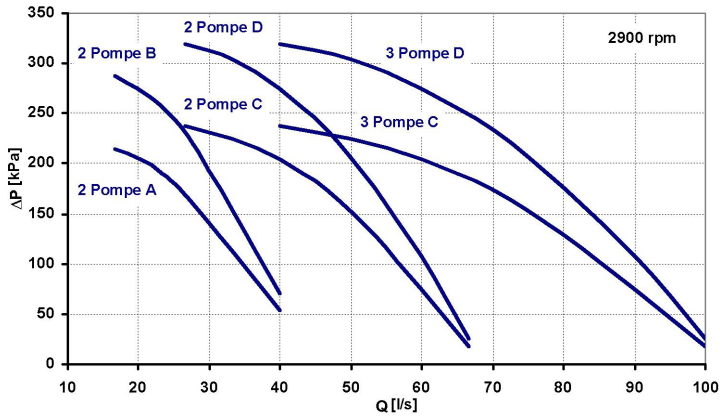

Attention: the evaporator pressure drops have to be taken from the heads represented in these diagrams in order to obtain the available head values.



Not available with unit in extremely low noise configuration (EN)



Check availability of the different type of pump with size in the 'Option compatibility' table.

2PM / 3PM option performances (electric pump with 4-pole motor)

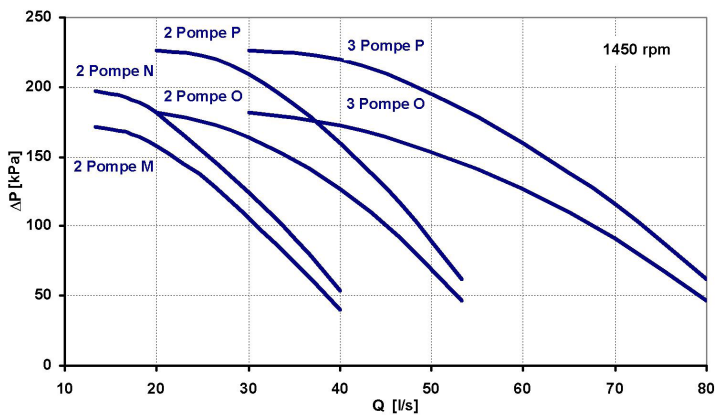

Attention: the evaporator pressure drops have to be taken from the heads represented in these diagrams in order to obtain the available head values.



Check availability of the different type of pump with size in the 'Option compatibility' table.



To the internal exchanger pressure drops must be added the pressure drops of the steel mesh mechanical filter (not supplied) that must be placed on the water input line. It is a device compulsory for the correct unit operation and it must be selected and installed by the Customer. It is forbidden the use of filters with the mesh pitch higher than 1,0 mm. Filters with higher mesh pitch can cause a bad unit operation and also its serious damaging.

Electrical data - HydroPack

To obtain the electrical consumption of the unit including the HydroPack accessory, the electrical data of the selected accessory are added to the standard electrical data indicated in the Electrical Data table.

HydroPack				
n° Pumps	Type	[kW]	[A]	
2	A	8	15,4	
2	B	11	20,8	
2	C	15	27,8	
2	D	22	40,4	
2	M	8	17	
2	N	11	22,6	
2	O	11	22,6	
2	P	15	30,8	
3	C	22,5	41,7	
3	D	33	60,6	
3	O	16,5	33,9	
3	P	22,5	46,2	

Accessories

PGCC - Condensing coil protection grilles and technical compartment

This accessory is used to protect the external coil from the accidental contact with external things or people.

Ideal for installation in places where persons can pass from, such as car parks, terraces, etc.

The accessory is provided and installed built-in the unit.



This option is not suitable for application in sulphuric environments.

PGCCH - Condensing coil anti-hail protection grilles

These accessories are to protect the external coil from hail damage. Indeed, hail impact can deform the coil fins worsening the heat exchange with the air.

The accessory is provided and installed built-in the unit.

CCCA - Copper / aluminium condensing coil with acrylic lining

Coils with copper pipes and aluminium fins with acrylic lacquering. Can be used in settings with moderately aggressive saline concentrations and other chemical agents.

Attention!

- cooling capacity variation -2.7%
- variation in compressor power input +4.2%
- operating range reduction -2.1°C

CCCA1 - Copper / aluminium condensing coil with Aluminium Energy Guard DCC treatment

A treatment which offers an optimal thermal exchange and guarantees and protects the finned coil exchangers from corrosion over time. Can be used in settings with very aggressive saline concentrations and other chemical agents in the air thus maintaining the performance of the coils over time.

CCCC - Copper / copper condensing coil

Coils with copper pipes, copper fins and brass structure. Can be used in settings with moderately aggressive saline concentrations and other chemical agents.



This option is not suitable for application in sulphuric environments



Option available on request

CREFB - ECOBREEZE external section fans consumption reduction device

An option which regards the external helical fans, as an alternative to the phase-cut device which is supplied as standard in ST and SC versions. It provides for an IP54 brushless electronically commutated electrical motor and incorporated thermal protection. Supplied with variable speed control. Standard for EN version.

CREFO - Device to reduce the consumption levels of on/off fans on the external section

Option that affects the external axial fans, as an alternative of the control device at variable speed, standard supplied. It requires the three-phase electric motor with an external rotor and built-in thermal protection, IP54 in progress. The condensation pressure automatic control occurs by the switching on or off of fans of the whole fan section.



The choice of this option limits the operating range in cooling with outdoor air temperatures higher than +5°C.

PFCP - Power-factor correction capacitors (cosφ > 0.9)

The component is necessary to lower the phase difference between current and voltage in the electromagnetic components of the unit (e.g. asynchronous motors). The component allows to put the cosφ power factor to values on average higher than 0.9, reducing the network reactive power. This often leads to an economic benefit which the energy provider grants to the final user.

The device is installed and wired built-in the unit.

REGBT - Device for the condensing coil partialization

The built-in device allows to extend the unit operating range in cooling down to an outdoor air temperature of -18°C.

CMSC9 - Serial communication module for Modbus supervisor

This enables the serial connection of the supervision system, using Modbus as the communication protocol. It enables access to the complete list of operational variables, commands and alarms. Using this accessory every unit can dialogue with the main supervision systems.

The device is installed and wired built-in the unit.



The total length of each serial line do not exceed 1000 meters and the line must be connected in bus typology (in/out)

CMSC10 - Serial communication module for LonWorks supervisor

This enables the serial connection of the supervision system which uses the LonWorks communication protocol. It enables access to a list of operating variables, commands and alarms which comply with the Echelon® standard.

The device is installed and wired built-in the unit.



The configuration and management activities for the LonWorks networks are the responsibility of the client.



LonWorks technology uses the LonTalk® protocol for communicating between the network nodes. Contact the service supplier for further information.



The total length of each serial line do not exceed 1000 meters and the line must be connected in bus typology (in/out)

CMSC11 - Serial communication module for BACnet-IP supervisor

Allows the serial connection to supervision systems by using BACnet-IP as a communication protocol. It allows the access to the entire list of operating variables, controls and alarms. With this accessory every unit can communicate with the main supervision systems.

The device is installed and wired built-in the unit.



The configuration and management activities for the BACnet networks are the responsibility of the client.



The total length of each serial line do not exceed 1000 meters and the line must be connected in bus typology (in/out)

ECS - ECOSHARE function for the automatic management of a group of units

The device allows automatic management of units that operate on the same hydraulic circuit, by creating a local communication network.

There are two control modes that can be set via a parameter during the activation stage. They both distribute the heat load on the available units by following the distribution logic to benefit from efficiency levels at part load.

Moreover:

Mode 1 - it keeps all the pumps active

Mode 2 - it activates only the pumps of the unit required to operate

The device allows for rotation based on the criterion of minimum wear and management of units in stand-by. There are various unit sizes. Every unit must be fitted with the ECOSHARE feature. The set of units is controlled by a Master unit.

The local network can be extended up to 7 units (1 Master and 6 Slave).



The unit supplied with this device can also be equipped at the same time with the RCMRX option and one of the CMSC9 / CMSC10 / CMSC11 options.

CBS - Compressor magnetothermic circuit breakers

The magnetothermic circuit breakers are inserted instead of the fuses for the protection against the short circuit and overload. In case of intervention they do not have to be replaced, as it happens with fuses.

SFSTR2 - Progressive compressor start-up device

This option is also called 'Soft starter'. Electronic device that automatically and gradually starts the compressors, thereby reducing the current peak generated in star-triangle start-ups and therefore reduces the mechanical stress on the motor and the electrodynamic stress on the power cables and on the mains.

The device is installed and wired built-in the unit.

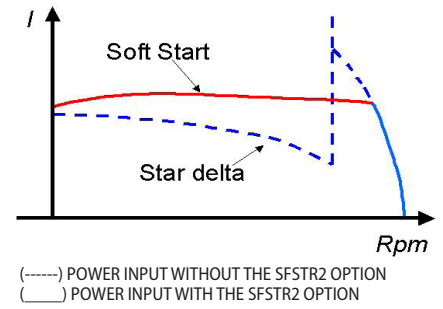

CONTA2 - Energy meter

Allows to display and record the unit's main electrical parameters. The data can be displayed with the user interface on the unit or via the supervisor through the specific protocol variables.

It is possible to control:

- voltage (V),
- absorbed current (A),
- frequency (Hz),
- cosfi,
- power input (kW),
- absorbed energy (kWh),
- harmonic components (%).

The device is installed and wired built-in the unit.



Only the following parameters are available on the LonWorks protocol: power input (kW) and absorbed energy (kWh)

SCP4 - Set point compensation with 0-10 V signal

This device enables the set-point to be varied which is pre-set using an external 0÷10V signal.

The device is installed and wired built-in the unit.

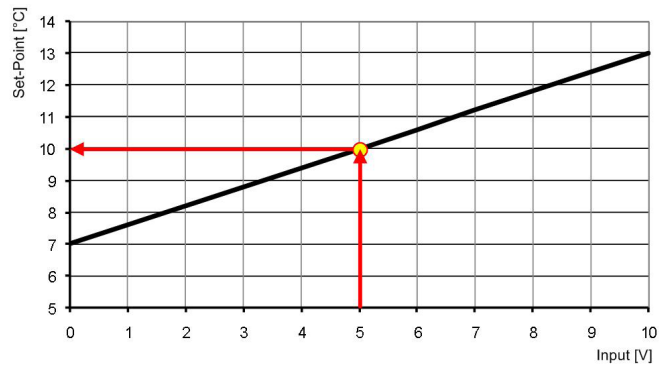

SPC1 - Set point compensation with 4-20mA signal

This device enables the set-point to be varied which is pre-set using an external 4-20mA signal.

The device is installed and wired built-in the unit.



SPC2 - Set-point compensation with outdoor air temperature probe

This device enables the set-point to be varied automatically which is pre-set depending on the outdoor air temperature. This device enables the liquid flow temperature to be obtained, which varies depending on external conditions, enabling energy savings throughout the entire system.

The device is installed and wired built-in the unit.

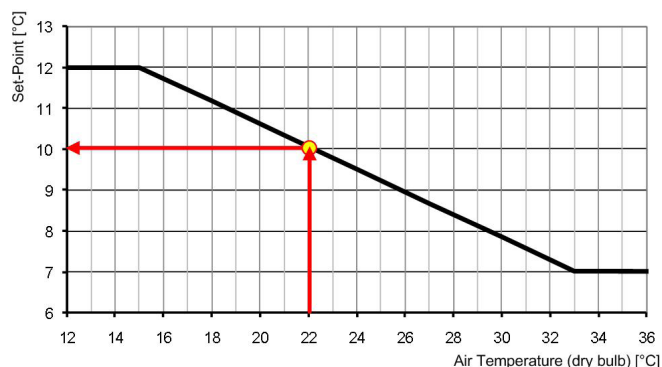

The device includes a probe controlled remotely from outside to measure the outdoor air temperature. (installation to be carried out by the customer). The connection cable length is 16 m.

RE-20 / RE-25 / RE-30 / RE-35 / RE-39 - Electrical panel antifreeze protection

This option is necessary for very cold climates, where the external temperature can be between -10°C and -39°C. It includes self-regulating temperature maintaining resistances which are able to protect the electrical panel against condensation and frost guaranteeing that it functions correctly. The choice of device should be carried out on the basis of the minimum temperatures reached at the unit installation site.

The device is built-in the unit.



It is necessary to make precautions against build up of snow and ice in front of the exhaust and outdoor air inlet locations.



This accessory operates even when the unit is switched off provided that the power supply is maintained active and the unit continues to be connected.



This accessory does not lead to substantial variations in the electrical data for the unit which has been declared in the Electrical Data section.

Accessories separately supplied

RCMRX - Remote control via microprocessor remote control

This option allows to have full control over all the unit functions from a remote position. It can be easily installed on the wall and has the same aspect and functions of the user interface on the unit.



All device functions can be repeated with a normal portable PC connected to the unit with an Ethernet cable and equipped with an internet navigation browser.



The device must be installed on the wall with suitable plugs and connected to the unit (installation and wiring to be conducted by the Customer). Maximum remote control distance 350 m without auxiliary power supply. For distances greater than 350 m and in any case less than 700 m it is necessary to install the 'PSX - Mains power unit' accessory.



Data and power supply serial connection cable n.1 twisted and shielded pair. Diameter of the individual conductor 0.8 mm.

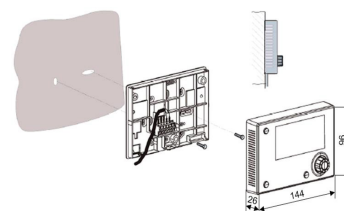

PSX - Mains power supply unit

The device allows the unit and the remote control to communicate with the user interface even when the serial line is longer than 350m.

It must be connected to the serial line at a distance of 350m from the unit and allows to extend the length to 700m maximum in total. The device requires an external power supply at 230V AC.



Power supply at 230V AC provided by Customer

AMMX - Spring antivibration mounts

The spring antivibration mounts are attached in special housing on the support frame and serve to smooth the vibrations produced by the unit thus reducing the noise transmitted to the support structure.

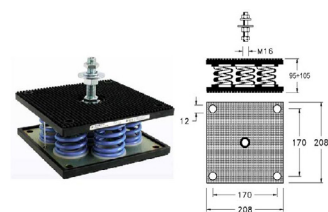

CSVX - Couple of manually operated shut-off valves

The kit allows to isolated the input and output water circuit. It includes:

- n. 2 of cast-iron shut-off butterfly valves with fast fittings and activation lever with a mechanical setting lock
- no. 2 quick connections



Installation is a responsibility of the Customer, outside the unit.



EXCELLENCE VERSION

Acoustic configuration: standard (ST) / compressor soundproofing (SC)

Cooling performance

Size	To (°C)	Entering external exchanger air temperature (°C)											
		25		30		35		40		48		52	
		kWf	kWe	kWf	kWe	kWf	kWe	kWf	kWe	kWf	kWe	kWf	kWe
200.2	5	499	117	479	127	457	138	439	152	406	178	302	142
	6	514	119	492	129	471	140	455	155	419	181	311	144
	7	528	121	510	131	486	142	469	157	435	184	323	146
	10	575	127	556	138	534	149	514	165	478	193	355	153
	15	662	140	642	151	618	164	597	180	499	178	-	-
	18	713	148	691	160	669	172	646	190	-	-	-	-
210.2	5	521	123	501	133	480	145	460	160	426	187	348	166
	6	536	125	516	135	495	147	476	162	440	190	360	169
	7	552	127	535	138	510	149	493	165	456	193	374	171
	10	601	134	583	145	561	157	539	173	501	202	410	179
	15	689	147	673	159	649	172	625	189	523	187	-	-
	18	744	156	721	168	702	181	674	199	-	-	-	-
220.2	5	559	130	540	141	518	153	492	169	448	198	367	174
	6	575	132	556	143	534	155	508	171	466	201	381	177
	7	592	134	573	145	550	158	527	174	482	204	394	180
	10	645	141	629	153	605	166	578	181	529	213	433	188
	15	739	154	719	167	701	181	671	198	553	197	-	-
	18	801	165	776	177	751	189	721	208	-	-	-	-
240.2	5	598	137	575	149	550	163	524	180	475	210	388	185
	6	613	139	593	151	567	165	541	183	493	213	403	188
	7	634	141	611	153	586	168	559	185	510	216	416	191
	10	691	147	670	159	641	175	614	193	561	226	458	199
	15	801	159	769	173	746	189	712	207	586	209	-	-
	18	861	166	838	182	809	198	770	217	-	-	-	-
260.2	5	651	152	623	165	598	181	571	199	522	231	367	170
	6	669	154	646	168	617	183	590	202	541	235	380	172
	7	687	157	666	170	637	186	609	205	561	239	394	175
	10	746	163	725	177	697	194	669	213	615	249	432	182
	15	859	176	828	191	808	209	770	229	642	230	-	-
	18	928	185	899	201	866	218	833	241	-	-	-	-
280.2	5	722	168	698	182	667	198	633	218	577	252	468	218
	6	749	171	720	185	688	201	653	222	596	256	483	221
	7	771	174	741	187	709	204	680	224	619	260	502	225
	10	841	182	813	197	780	214	745	234	680	272	551	235
	15	971	199	939	216	907	234	866	255	710	252	-	-
	18	1042	211	1011	228	977	245	935	269	-	-	-	-
320.2	5	796	185	768	200	736	218	701	240	636	278	529	252
	6	820	188	792	203	759	221	724	243	657	282	547	255
	7	844	191	816	206	782	224	747	247	680	287	566	259
	10	919	200	891	216	855	235	818	257	749	300	624	272
	15	1050	216	1020	236	985	255	945	279	783	277	-	-
	18	1123	229	1094	248	1072	269	1018	293	-	-	-	-
340.2	5	853	199	823	215	787	234	748	259	686	302	567	267
	6	877	202	848	218	815	238	775	263	710	305	587	271
	7	905	205	874	221	839	241	799	267	734	309	607	274
	10	984	215	957	232	918	253	882	277	811	324	671	288
	15	1123	232	1091	253	1055	273	1015	300	847	300	-	-
	18	1207	245	1172	265	1138	286	1090	315	-	-	-	-
360.2	5	911	214	881	231	850	251	803	275	728	318	614	289
	6	938	218	907	235	876	256	834	280	757	323	638	294
	7	965	222	934	238	902	260	860	284	781	328	658	299
	10	1050	233	1023	252	981	272	942	297	857	344	722	313
	15	1189	256	1163	277	1132	298	1087	327	895	318	-	-
	18	1267	271	1238	292	1208	313	1161	344	-	-	-	-

Size	To (°C)	Entering external exchanger air temperature (°C)											
		25		30		35		40		48		52	
		kWf	kWe	kWf	kWe	kWf	kWe	kWf	kWe	kWf	kWe	kWf	kWe
400.2	5	1003	234	965	254	919	278	883	306	796	353	566	269
	6	1041	238	995	257	955	283	914	310	828	360	589	274
	7	1072	241	1033	261	979	286	946	315	861	366	612	279
	10	1172	252	1129	274	1079	300	1038	328	951	380	676	290
	15	1349	271	1300	297	1250	323	1198	356	993	352	-	-
	18	1454	286	1405	311	1352	338	1294	373	-	-	-	-
440.2	5	1124	267	1082	290	1033	316	955	348	898	399	668	318
	6	1167	271	1116	293	1065	321	999	352	930	405	692	323
	7	1202	275	1159	298	1099	325	1043	357	963	411	716	328
	10	1312	287	1266	311	1213	340	1165	371	1066	431	793	344
	15	1510	308	1458	338	1412	368	1345	402	1113	398	-	-
	18	1631	325	1575	354	1532	385	1454	420	-	-	-	-
500.2	5	1238	293	1196	316	1144	343	1095	376	998	441	750	347
	6	1276	298	1230	321	1183	347	1132	382	1036	446	779	351
	7	1315	303	1268	326	1218	352	1169	388	1074	455	807	358
	10	1423	316	1381	344	1337	372	1285	408	1180	476	887	374
	15	1617	353	1567	376	1522	406	1470	448	1232	440	-	-
	18	1734	375	1693	401	1647	433	1589	475	-	-	-	-
540.2	5	1355	318	1306	344	1245	376	1194	414	1097	485	773	363
	6	1394	323	1343	349	1284	381	1232	420	1129	490	796	366
	7	1436	327	1384	354	1321	387	1272	425	1168	500	824	374
	10	1566	343	1518	375	1454	407	1400	448	1288	527	908	394
	15	1791	373	1741	408	1677	441	1630	491	1345	488	-	-
	18	1961	402	1895	431	1810	466	1751	517	-	-	-	-
580.2	5	1449	341	1398	369	1336	402	1280	442	1152	511	867	404
	6	1490	346	1440	374	1387	409	1321	448	1193	518	898	410
	7	1533	351	1484	379	1430	415	1362	454	1233	525	928	415
	10	1671	367	1645	401	1563	434	1521	475	1367	551	1028	435
	15	1931	400	1866	435	1809	473	1733	517	1427	509	-	-
	18	2096	428	1999	455	1957	496	1860	542	-	-	-	-

kWf = Cooling capacity in kW

kWe = Compressor power input in kW

To (°C) = internal exchanger outlet water temperature (evaporator)

Performances in function of the inlet/outlet water temperature differential = 5°C

The data do not consider the part related to the pumps, required to overcome the pressure drop for the solution circulation inside the exchangers

Internal exchanger (evaporator) pressure drop

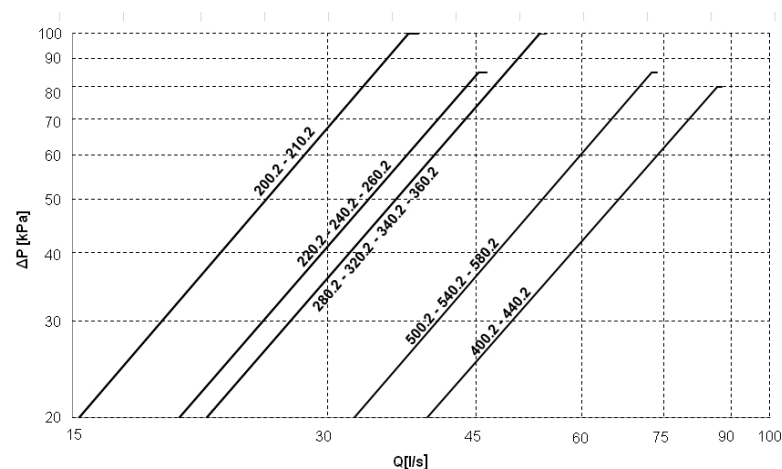

The pressure drops are calculated considering a water temperature of 7°C

Q = water flow-rate [l/s]
DP = water side pressure drops (kPa)

The water flow-rate must be calculated with the following formula

$$Q \text{ [l/s]} = \frac{kWf}{4,186 \times DT}$$

kWf = Cooling capacity in kW
DT = Temperature difference between inlet / outlet water



To the internal exchanger pressure drops must be added the pressure drops of the steel mesh mechanical filter (not supplied) that must be placed on the water input line. It is a device compulsory for the correct unit operation and it must be selected and installed by the Customer. It is forbidden the use of filters with the mesh pitch higher than 1,0 mm. Filters with higher mesh pitch can cause a bad unit operation and also its serious damaging.

PREMIUM VERSION

Acoustic configuration: standard (ST) / compressor soundproofing (SC)

Cooling performance

Size	To (°C)	Entering external exchanger air temperature(°C)											
		25		30		35		40		44		50	
		kWf	kWe	kWf	kWe	kWf	kWe	kWf	kWe	kWf	kWe	kWf	kWe
200.2	5	451	118	436	129	424	142	403	154	388	165	310	153
	6	476	121	456	131	448	145	422	157	407	169	325	156
	7	501	124	486	135	468	148	442	160	427	172	341	160
	10	553	131	533	142	511	154	488	168	469	180	374	167
	15	625	141	603	152	578	165	557	181	473	157	-	-
	18	657	146	636	157	609	170	545	167	465	144	-	-
210.2	5	474	126	457	138	442	151	424	164	407	176	327	162
	6	499	130	488	142	466	154	448	168	429	180	344	166
	7	524	133	509	145	490	158	469	172	450	184	361	170
	10	582	140	562	153	539	166	513	180	493	193	396	178
	15	657	152	633	164	609	177	586	194	497	169	-	-
	18	689	158	666	169	638	183	575	180	488	155	-	-
220.2	5	498	135	481	146	465	160	446	174	427	187	328	161
	6	521	138	512	151	486	164	468	178	445	191	343	164
	7	546	141	534	154	514	168	492	182	474	196	364	169
	10	615	150	590	163	565	177	538	191	518	206	398	177
	15	691	163	665	176	642	190	614	206	523	180	-	-
	18	725	169	699	181	670	196	605	193	512	165	-	-
240.2	5	570	148	549	160	524	174	499	188	478	201	388	183
	6	586	150	565	163	540	177	515	191	493	204	400	186
	7	603	153	581	165	560	180	531	194	508	207	413	189
	10	661	162	640	176	610	189	582	205	558	219	453	199
	15	754	180	724	192	697	207	665	220	563	192	-	-
	18	805	191	780	203	747	220	662	210	564	180	-	-
260.2	5	612	165	592	178	565	193	539	208	516	222	413	196
	6	631	168	609	181	582	196	558	212	534	227	427	199
	7	649	170	626	184	601	199	574	216	550	231	440	203
	10	707	181	684	195	658	210	627	228	601	243	481	214
	15	805	201	777	215	749	232	716	245	607	213	-	-
	18	864	215	836	229	804	247	710	234	605	200	-	-
280.2	5	679	186	656	201	627	216	598	233	572	248	423	200
	6	702	190	674	205	645	220	616	237	586	252	434	203
	7	721	194	693	209	668	225	639	242	607	257	449	207
	10	788	208	758	222	729	237	695	256	667	271	493	219
	15	888	231	864	245	827	263	794	275	673	237	-	-
	18	948	245	927	259	881	280	782	263	670	225	-	-
320.2	5	764	201	738	219	700	238	665	258	634	276	463	220
	6	786	204	754	222	721	242	689	262	651	279	475	223
	7	816	208	781	227	744	245	707	266	675	285	493	227
	10	886	219	858	240	821	259	777	281	742	301	541	240
	15	1011	241	975	260	935	282	887	303	749	263	-	-
	18	1092	256	1059	277	1008	299	889	288	753	247	-	-
340.2	5	813	215	780	234	739	255	703	275	671	294	469	231
	6	834	218	799	237	762	258	726	279	686	298	479	234
	7	858	220	828	240	785	262	749	284	715	303	500	238
	10	937	230	906	252	853	266	823	297	801	318	560	250
	15	1076	250	1035	271	993	295	940	320	808	278	-	-
	18	1178	268	1112	286	1086	312	935	299	828	258	-	-
360.2	5	866	234	830	255	786	278	746	300	704	319	444	222
	6	887	237	846	258	808	280	765	305	729	325	460	226
	7	917	242	877	264	837	286	789	310	751	331	474	231
	10	1008	255	958	278	918	299	872	325	823	349	519	243
	15	1148	278	1113	302	1060	329	996	349	831	305	-	-
	18	1239	292	1189	315	1128	342	994	330	843	285	-	-

Size	To (°C)	Entering external exchanger air temperature (°C)											
		25		30		35		40		44		50	
		kWf	kWe	kWf	kWe	kWf	kWe	kWf	kWe	kWf	kWe	kWf	kWe
400.2	5	947	259	907	281	864	303	822	327	783	349	546	264
	6	966	263	927	285	890	308	846	333	802	354	559	268
	7	994	268	961	292	916	314	876	341	832	361	580	273
	10	1086	287	1050	310	998	332	958	361	906	382	632	288
	15	1226	319	1189	342	1134	367	1095	389	915	334	-	-
	18	1311	337	1269	366	1208	390	1080	372	913	315	-	-
440.2	5	1058	296	1017	319	970	342	924	369	882	392	646	305
	6	1081	301	1041	325	999	348	950	375	903	397	662	310
	7	1117	310	1076	332	1026	354	977	382	935	406	685	316
	10	1223	335	1168	353	1121	379	1066	407	1019	429	746	334
	15	1400	379	1321	395	1272	424	1218	438	1028	376	-	-
	18	1507	404	1412	422	1363	452	1199	421	1024	360	-	-
500.2	5	1166	325	1127	350	1080	376	1029	402	983	428	737	339
	6	1197	332	1157	357	1110	383	1058	410	1012	435	759	345
	7	1229	339	1190	364	1142	390	1090	419	1048	445	786	352
	10	1324	359	1285	388	1245	415	1187	446	1143	473	857	374
	15	1482	393	1445	428	1418	458	1356	480	1154	413	-	-
	18	1577	414	1541	452	1521	484	1335	459	1143	394	-	-
540.2	5	1305	354	1249	387	1185	420	1125	455	1064	487	624	309
	6	1341	360	1285	393	1222	426	1155	463	1094	493	642	313
	7	1390	368	1325	399	1260	433	1192	473	1132	502	664	319
	10	1511	389	1445	422	1394	460	1310	498	1246	531	731	338
	15	1723	426	1654	461	1598	510	1497	536	1257	465	-	-
	18	1864	453	1793	494	1712	537	1509	515	1293	443	-	-
580.2	5	1401	368	1342	400	1291	437	1215	473	1153	509	770	366
	6	1440	374	1381	407	1318	443	1254	480	1195	514	798	370
	7	1496	381	1433	416	1359	450	1298	492	1233	522	823	376
	10	1623	402	1559	438	1496	473	1419	516	1354	553	904	398
	15	1851	440	1788	476	1714	521	1621	556	1367	484	-	-
	18	2015	469	1940	507	1843	549	1621	528	1376	453	-	-

kWf = Cooling capacity in kW

kWe = Compressor power input in kW

To (°C) = internal exchanger outlet water temperature (evaporator)

Performances in function of the inlet/outlet water temperature differential = 5°C

The data do not consider the part related to the pumps, required to overcome the pressure drop for the solution circulation inside the exchangers

Internal exchanger (evaporator) pressure drop

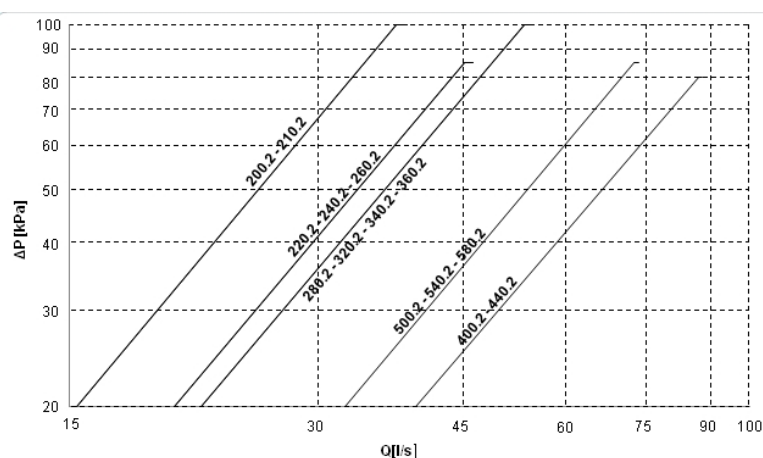

The pressure drops are calculated considering a water temperature of 7°C

Q = water flow-rate [l/s]

DP = water side pressure drops (kPa)

The water flow-rate must be calculated with the following formula

$$Q \text{ [l/s]} = \frac{kWf}{(4,186 \times DT)}$$

kWf = Cooling capacity in kW

DT = Temperature difference between inlet / outlet water



To the internal exchanger pressure drops must be added the pressure drops of the steel mesh mechanical filter (not supplied) that must be placed on the water input line. It is a device compulsory for the correct unit operation and it must be selected and installed by the Customer. It is forbidden the use of filters with the mesh pitch higher than 1,0 mm. Filters with higher mesh pitch can cause a bad unit operation and also its serious damaging.

EXCELLENCE VERSION

Acoustic configuration: super-silenced (EN)

Cooling performance

Size	To (°C)	Entering external exchanger air temperature (°C)											
		25		30		35		40		46		52	
		kWf	kWe	kWf	kWe	kWf	kWe	kWf	kWe	kWf	kWe	kWf	kWe
200.2	5	489	121	467	131	446	142	423	154	393	171	263	119
	6	503	123	481	133	460	144	436	157	406	173	271	121
	7	518	125	498	136	474	147	452	159	419	176	280	123
	10	567	132	543	142	521	155	495	168	461	185	308	129
	15	648	145	626	157	601	170	570	183	544	191	-	-
	18	698	154	678	166	647	179	616	194	542	180	-	-
210.2	5	517	127	495	138	472	151	447	164	415	182	284	128
	6	532	129	510	140	487	153	462	166	429	185	294	130
	7	548	131	527	142	502	155	479	169	443	187	303	132
	10	601	138	577	150	552	163	525	178	488	197	334	139
	15	689	151	665	164	641	178	607	193	576	204	-	-
	18	742	160	718	173	690	188	654	204	575	192	-	-
220.2	5	545	133	524	145	495	158	470	172	436	190	332	154
	6	561	135	540	147	513	161	486	174	450	193	343	156
	7	579	137	556	149	529	163	502	177	465	196	355	159
	10	637	144	611	157	581	171	552	186	510	206	389	166
	15	735	158	705	171	677	186	640	203	602	213	-	-
	18	792	167	764	181	729	196	690	213	604	199	-	-
240.2	5	591	142	564	156	537	170	507	186	470	205	339	155
	6	609	143	582	158	554	173	523	189	485	208	349	157
	7	634	147	603	161	571	175	539	192	501	211	361	160
	10	690	155	659	168	631	184	597	200	553	221	398	167
	15	794	168	765	183	731	200	692	217	653	229	-	-
	18	858	177	827	192	791	210	748	228	653	214	-	-
260.2	5	639	158	614	171	584	187	556	204	514	225	335	145
	6	658	160	633	174	604	190	574	207	532	228	347	147
	7	679	163	652	177	623	193	592	210	550	232	359	149
	10	741	171	714	186	686	203	652	220	603	244	393	157
	15	846	186	821	203	788	220	752	240	711	252	-	-
	18	914	197	885	214	854	232	807	252	714	237	-	-
280.2	5	709	174	684	188	652	206	617	223	574	247	472	219
	6	730	177	705	191	671	208	637	226	593	250	488	222
	7	756	180	726	194	692	212	661	230	613	254	504	226
	10	824	189	791	205	759	223	724	241	674	267	555	237
	15	948	209	916	227	879	243	837	265	796	276	-	-
	18	1017	222	985	239	947	258	902	280	791	260	-	-
320.2	5	797	189	762	205	729	225	689	246	641	271	510	239
	6	822	192	791	208	751	228	713	249	662	275	527	243
	7	847	195	816	211	775	231	737	251	683	280	544	247
	10	926	203	893	221	854	242	813	263	752	292	599	257
	15	1069	219	1031	239	993	263	944	286	888	302	-	-
	18	1160	231	1114	251	1077	275	1022	300	891	283	-	-
340.2	5	842	202	807	219	770	240	704	263	678	290	531	247
	6	868	205	835	222	795	243	733	267	700	294	548	251
	7	894	208	861	225	822	247	761	271	723	299	566	255
	10	981	217	941	236	900	258	848	284	800	315	626	268
	15	1136	235	1085	256	1031	277	992	305	944	325	-	-
	18	1223	247	1172	269	1109	288	1079	322	943	304	-	-
360.2	5	856	217	824	235	784	258	753	275	688	311	511	255
	6	883	220	849	239	809	262	779	281	710	316	528	259
	7	909	223	875	242	834	266	806	286	733	321	545	263
	10	993	233	955	254	914	278	885	303	813	338	604	276
	15	1152	253	1101	275	1046	298	1016	331	960	349	-	-
	18	1242	267	1197	291	1126	310	1095	348	959	327	-	-

Size	To (°C)	Entering external exchanger air temperature(°C)											
		25		30		35		40		46		52	
		kWf	kWe	kWf	kWe	kWf	kWe	kWf	kWe	kWf	kWe	kWf	kWe
400.2	5	986	243	949	262	906	286	862	310	795	341	601	277
	6	1023	247	984	268	934	291	890	315	823	348	623	282
	7	1053	251	1013	272	962	295	917	320	852	354	645	287
	10	1147	264	1104	287	1058	311	1006	338	938	373	710	303
	15	1308	291	1264	315	1212	341	1164	371	1108	385	-	-
	18	1405	310	1359	331	1304	359	1242	389	1104	364	-	-
440.2	5	1100	272	1050	295	1001	322	952	334	879	387	611	291
	6	1132	276	1083	300	1034	327	983	342	907	394	631	295
	7	1165	280	1117	305	1066	332	1013	350	941	401	655	301
	10	1270	293	1217	320	1164	348	1103	375	1030	421	717	316
	15	1450	321	1396	348	1347	384	1279	415	1217	436	-	-
	18	1561	339	1508	367	1456	405	1384	440	1210	411	-	-
500.2	5	1194	295	1151	321	1104	352	1024	382	963	422	662	307
	6	1229	300	1186	327	1138	357	1055	387	994	429	683	312
	7	1264	304	1221	332	1173	363	1094	393	1031	437	709	318
	10	1377	318	1320	348	1273	379	1186	416	1130	459	776	334
	15	1569	349	1516	379	1461	416	1397	453	1334	475	-	-
	18	1682	367	1635	399	1574	437	1502	478	1314	443	-	-

kWf = Cooling capacity in kW

kWe = Compressor power input in kW

To (°C) = internal exchanger outlet water temperature (evaporator)

Performances in function of the inlet/outlet water temperature differential = 5°C

The data do not consider the part related to the pumps, required to overcome the pressure drop for the solution circulation inside the exchangers

Internal exchanger (evaporator) pressure drop

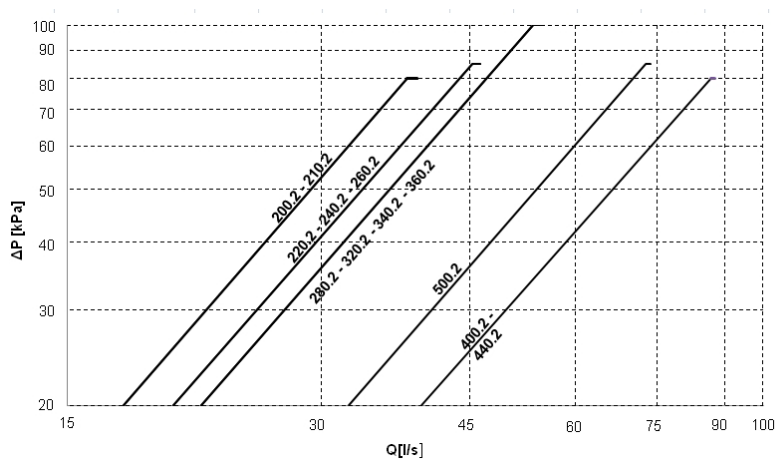

The pressure drops are calculated considering a water temperature of 7°C

Q = water flow-rate[l/s]

DP = water side pressure drops (kPa)

The water flow-rate must be calculated with the following formula

$$Q [l/s] = kWf / (4,186 \times DT)$$

kWf = Cooling capacity in kW

DT = Temperature difference between inlet / outlet water



To the internal exchanger pressure drops must be added the pressure drops of the steel mesh mechanical filter (not supplied) that must be placed on the water input line. It is a device compulsory for the correct unit operation and it must be selected and installed by the Customer. It is forbidden the use of filters with the mesh pitch higher than 1,0 mm. Filters with higher mesh pitch can cause a bad unit operation and also its serious damaging.

PREMIUM VERSION

Acoustic configuration: super-silenced (EN)

Cooling performances

Size	To (°C)	Entering external exchanger air temperature (°C)											
		25		30		35		40		42		50	
		kWf	kWe	kWf	kWe	kWf	kWe	kWf	kWe	kWf	kWe	kWf	kWe
200.2	5	438	128	428	140	409	153	390	167	380	172	236	114
	6	466	132	447	144	429	157	407	171	398	177	247	117
	7	488	136	470	148	448	160	421	174	413	180	256	119
	10	532	143	513	156	489	170	463	184	452	190	280	125
	15	598	156	572	168	544	182	544	193	516	188	-	-
	18	628	162	601	174	572	189	543	185	500	173	-	-
210.2	5	459	134	446	147	424	159	406	173	397	179	254	119
	6	483	138	466	150	449	164	429	178	418	184	267	122
	7	506	141	487	154	469	168	442	182	434	188	278	125
	10	557	151	536	164	511	178	486	193	475	199	304	132
	15	625	165	600	177	570	192	571	203	542	197	-	-
	18	655	171	628	184	597	199	568	195	525	181	-	-
220.2	5	491	138	472	150	456	165	436	179	430	186	359	167
	6	515	142	503	156	477	169	462	185	449	190	363	171
	7	543	147	523	160	504	174	479	188	473	196	382	176
	10	595	156	575	170	555	184	528	200	516	207	417	186
	15	673	172	650	185	619	200	620	211	589	205	-	-
	18	709	179	682	192	649	208	617	203	572	189	-	-
240.2	5	550	157	526	170	500	184	474	198	465	206	359	170
	6	565	160	541	173	515	187	488	202	478	209	369	173
	7	580	163	556	176	533	191	505	207	492	213	379	176
	10	632	173	607	187	579	202	548	218	540	226	416	187
	15	717	192	689	207	662	224	643	229	616	224	-	-
	18	768	204	738	220	704	237	657	226	612	211	-	-
260.2	5	611	172	584	187	555	202	526	219	537	227	458	158
	6	628	174	601	190	571	205	541	223	546	230	473	161
	7	646	177	619	193	593	209	558	227	558	234	488	164
	10	703	188	678	204	649	221	610	240	593	248	538	173
	15	802	207	777	224	739	243	717	252	681	246	-	-
	18	864	220	830	238	791	257	733	246	680	231	-	-
280.2	5	680	186	649	203	617	221	581	239	568	247	420	200
	6	695	189	664	206	631	223	599	243	586	251	433	203
	7	720	192	688	210	656	228	619	248	604	256	447	207
	10	789	204	755	222	720	241	680	262	664	271	491	219
	15	900	225	867	242	829	265	798	275	759	269	-	-
	18	967	238	925	257	877	278	818	268	762	252	-	-
320.2	5	751	205	718	223	682	242	647	262	634	272	486	230
	6	773	208	739	227	702	246	665	266	652	276	500	234
	7	795	212	760	231	723	250	691	272	672	281	515	238
	10	863	224	834	245	797	264	752	287	733	297	562	251
	15	980	247	945	266	907	291	883	302	838	295	-	-
	18	1059	264	1022	286	971	308	909	296	842	277	-	-
340.2	5	798	220	767	241	727	260	691	282	671	291	462	219
	6	819	224	784	243	747	265	711	287	694	297	478	224
	7	843	228	810	248	772	269	734	292	715	302	493	227
	10	919	242	884	262	844	284	802	309	782	319	539	240
	15	1039	266	1007	288	957	312	942	324	894	317	-	-
	18	1131	286	1088	309	1033	333	963	318	892	297	-	-
360.2	5	856	240	815	259	778	280	737	303	719	313	547	262
	6	872	243	838	264	800	285	760	308	741	317	564	267
	7	899	248	868	270	829	291	785	315	765	326	582	274
	10	981	266	943	285	901	308	855	333	836	343	636	288
	15	1114	296	1073	317	1029	343	1004	350	955	341	-	-
	18	1186	314	1140	338	1084	362	1023	346	953	323	-	-

Size	To (°C)	Entering external exchanger air temperature (°C)											
		25		30		35		40		42		50	
		kWf	kWe	kWf	kWe	kWf	kWe	kWf	kWe	kWf	kWe	kWf	kWe
400.2	5	937	264	896	286	853	308	809	333	789	343	600	281
	6	956	268	916	290	879	313	833	339	811	349	616	286
	7	983	274	948	297	903	319	857	345	841	357	639	293
	10	1069	293	1030	314	990	340	937	367	914	377	694	309
	15	1210	326	1163	349	1119	378	1100	385	1044	375	-	-
	18	1295	345	1242	370	1186	399	1114	378	1034	352	-	-
440.2	5	1050	287	1004	313	953	341	900	371	881	383	642	313
	6	1081	292	1033	319	982	346	928	377	903	389	658	318
	7	1122	297	1072	325	1017	353	956	383	937	396	683	324
	10	1228	315	1168	342	1121	376	1050	405	1025	417	747	341
	15	1405	345	1351	375	1284	408	1232	425	1171	414	-	-
	18	1502	362	1460	394	1361	427	1283	416	1173	388	-	-
500.2	5	1171	326	1123	354	1065	380	1010	411	983	424	727	337
	6	1203	332	1152	359	1096	387	1040	414	1015	433	751	343
	7	1236	338	1184	366	1134	396	1071	424	1048	441	775	350
	10	1351	361	1298	389	1237	421	1170	453	1144	465	846	369
	15	1536	402	1472	430	1402	464	1374	476	1307	462	-	-
	18	1629	426	1567	460	1497	493	1400	469	1298	434	-	-
540.2	5	1272	347	1223	385	1171	419	1091	453	1069	468	711	344
	6	1315	357	1254	390	1199	423	1129	462	1097	476	730	350
	7	1359	367	1300	398	1244	432	1167	471	1139	487	758	358
	10	1476	388	1414	421	1350	457	1283	501	1243	514	828	377
	15	1678	427	1610	463	1551	507	1507	526	1420	510	-	-
	18	1817	454	1748	496	1673	540	1557	517	1435	483	-	-
580.2	5	1340	376	1291	411	1231	447	1163	485	1132	501	768	373
	6	1387	385	1328	418	1258	452	1202	495	1165	509	791	379
	7	1426	392	1367	426	1316	464	1240	505	1206	519	819	386
	10	1550	415	1498	451	1419	487	1355	534	1327	551	901	410
	15	1762	457	1702	497	1632	542	1591	561	1515	547	-	-
	18	1924	491	1830	532	1737	569	1629	549	1501	511	-	-

kWf = Cooling capacity in kW

kWe = Compressor power input in kW

To (°C) = internal exchanger outlet water temperature (evaporator)

Performances in function of the inlet/outlet water temperature differential = 5°C

The data do not consider the part related to the pumps, required to overcome the pressure drop for the solution circulation inside the exchangers

Internal exchanger (evaporator) pressure drop

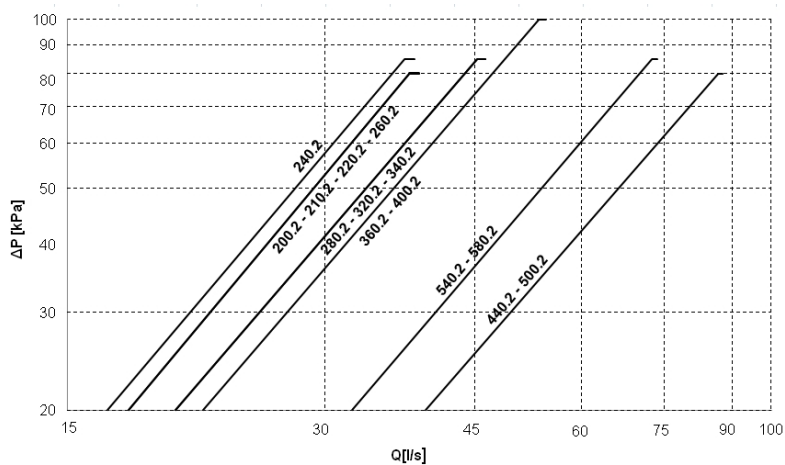

The pressure drops are calculated considering a water temperature of 7°C

Q = water flow-rate [l/s]

DP = water side pressure drops (kPa)

The water flow-rate must be calculated with the following formula

$$Q [l/s] = kWf / (4,186 \times DT)$$

kWf = Cooling capacity in kW

DT = Temperature difference between inlet / outlet water



To the internal exchanger pressure drops must be added the pressure drops of the steel mesh mechanical filter (not supplied) that must be placed on the water input line. It is a device compulsory for the correct unit operation and it must be selected and installed by the Customer. It is forbidden the use of filters with the mesh pitch higher than 1,0 mm. Filters with higher mesh pitch can cause a bad unit operation and also its serious damaging.

EXCELLENCE VERSION

Acoustic configuration: standard (ST) / compressor soundproofing (SC)

Cooling performance at part load

Size	Load	Entering external exchanger air temperature (°C)											
		35°C			30°C			25°C			20°C		
		kWf	kWe_tot	EER	kWf	kWe_tot	EER	kWf	kWe_tot	EER	kWf	kWe_tot	EER
200.2	100%	487	153	3,18	511	142	3,59	528	132	4,00	537	123	4,37
	75%	365	111	3,29	383	103	3,71	396	96	4,10	403	88	4,57
	50%	243	77	3,14	255	72	3,55	264	67	3,96	269	62	4,33
	25%	122	39	3,11	128	35	3,65	132	32	4,11	134	29	4,58
210.2	100%	511	160	3,19	536	149	3,60	554	138	4,02	564	129	4,38
	75%	383	114	3,37	402	106	3,81	415	98	4,25	423	91	4,65
	50%	255	80	3,19	268	74	3,60	277	69	4,02	282	64	4,39
	25%	128	39	3,30	134	35	3,87	138	32	4,35	141	29	4,85
220.2	100%	551	171	3,23	578	159	3,64	597	147	4,06	608	137	4,43
	75%	413	121	3,42	433	112	3,85	448	104	4,31	456	97	4,71
	50%	275	86	3,20	289	80	3,62	299	74	4,04	304	69	4,41
	25%	138	42	3,24	144	38	3,79	149	35	4,27	152	32	4,76
240.2	100%	585	182	3,22	613	169	3,64	634	156	4,06	645	146	4,43
	75%	439	129	3,40	460	120	3,84	476	111	4,29	484	103	4,69
	50%	292	91	3,20	307	85	3,62	317	79	4,04	323	73	4,41
	25%	146	47	3,11	153	42	3,64	159	39	4,10	161	35	4,57
260.2	100%	637	200	3,19	668	185	3,61	691	172	4,02	703	160	4,39
	75%	478	142	3,37	501	132	3,80	518	122	4,25	527	113	4,65
	50%	319	99	3,21	334	92	3,62	345	85	4,05	352	80	4,42
	25%	159	47	3,42	167	42	4,00	173	38	4,51	176	35	5,02
280.2	100%	709	220	3,22	744	205	3,63	769	190	4,05	782	177	4,42
	75%	532	159	3,34	558	148	3,77	577	137	4,21	587	127	4,61
	50%	354	112	3,17	372	104	3,59	384	96	4,00	391	90	4,37
	0,25	177	55	3,25	186	49	3,81	192	45	4,29	196	41	4,78
320.2	100%	782	241	3,24	821	224	3,66	848	208	4,09	864	194	4,46
	75%	587	173	3,39	616	161	3,82	636	149	4,27	648	139	4,67
	50%	391	122	3,22	410	113	3,64	424	105	4,06	432	97	4,43
	25%	196	62	3,18	205	55	3,72	212	51	4,19	216	46	4,67
340.2	100%	839	260	3,23	880	242	3,64	910	224	4,06	926	209	4,43
	75%	630	189	3,33	660	176	3,76	683	162	4,20	695	151	4,60
	50%	420	129	3,24	440	120	3,67	455	111	4,09	463	104	4,47
	25%	210	55	3,84	220	49	4,49	228	45	5,06	232	41	5,64
360.2	100%	902	279	3,24	946	259	3,66	978	240	4,08	996	224	4,45
	75%	677	202	3,34	710	188	3,77	734	174	4,21	747	162	4,61
	50%	451	141	3,21	473	131	3,62	489	121	4,05	498	113	4,42
	25%	226	61	3,68	237	55	4,30	245	50	4,85	249	46	5,40
400.2	100%	977	309	3,16	1025	287	3,57	1059	266	3,99	1078	248	4,35
	50%	733	222	3,30	769	207	3,72	794	191	4,16	808	178	4,55
	50%	488	155	3,15	512	144	3,56	530	133	3,98	539	124	4,34
	25%	244	78	3,12	256	70	3,65	265	64	4,11	269	59	4,58
440.2	100%	1095	349	3,14	1149	324	3,55	1188	300	3,96	1209	280	4,32
	75%	822	249	3,30	862	231	3,72	891	214	4,16	907	199	4,56
	50%	548	174	3,14	575	162	3,55	594	150	3,96	604	140	4,33
	25%	274	89	3,07	287	80	3,59	297	73	4,04	302	67	4,51
500.2	100%	1219	378	3,23	1279	351	3,64	1322	325	4,06	1345	303	4,44
	75%	914	263	3,48	959	245	3,92	991	226	4,38	1009	210	4,79
	50%	610	191	3,19	639	177	3,61	661	164	4,03	673	153	4,40
	25%	305	99	3,08	320	89	3,61	330	81	4,06	336	74	4,53
540.2	100%	1321	414	3,19	1386	385	3,60	1432	356	4,02	1458	332	4,39
	75%	991	292	3,39	1039	272	3,83	1074	251	4,28	1093	234	4,68
	50%	660	206	3,20	693	191	3,62	716	177	4,04	729	165	4,42
	25%	330	95	3,46	346	85	4,05	358	78	4,56	364	72	5,09

Size	Load	Entering external exchanger air temperature (°C)											
		35°C			30°C			25°C			20°C		
		kWf	kWe_tot	EER	kWf	kWe_tot	EER	kWf	kWe_tot	EER	kWf	kWe_tot	EER
580.2	100%	1431	444	3,22	1501	413	3,64	1551	382	4,06	1579	357	4,43
	75%	1073	313	3,43	1126	291	3,87	1164	269	4,32	1184	250	4,73
	50%	715	223	3,21	750	207	3,63	776	191	4,05	790	178	4,42
	25%	358	103	3,47	375	92	4,06	388	85	4,58	395	77	5,10

Load = % of cooling capacity compared to the value at full load

kWf = Cooling capacity in kW

kWe_tot = Unit total power input in kW

The data do not consider the part related to the pumps, required to overcome the pressure drop for the solution circulation inside the exchangers

Internal exchanger water = leaving 7°C / entering 12°C / variable flow-rate with external exchanger air temperature

PREMIUM VERSION

Acoustic configuration: standard (ST) / compressor soundproofing (SC)

Cooling performance at part load

Size	Load	Entering external exchanger air temperature (°C)											
		35°C			30°C			25°C			20°C		
		kWf	kWe_tot	EER	kWf	kWe_tot	EER	kWf	kWe_tot	EER	kWf	kWe_tot	EER
200.2	100%	468	159	2,95	491	147	3,33	508	136	3,72	517	127	4,06
	75%	351	114	3,07	368	106	3,47	381	98	3,88	387	91	4,24
	50%	234	80	2,92	246	74	3,31	254	69	3,69	258	64	4,03
	25%	117	40	2,92	123	36	3,42	127	33	3,86	129	30	4,30
210.2	100%	491	169	2,91	515	157	3,28	532	145	3,66	541	136	4,00
	75%	368	117	3,13	386	109	3,53	399	101	3,95	406	94	4,32
	50%	245	82	2,97	257	77	3,36	266	71	3,75	271	66	4,10
	25%	123	40	3,05	129	36	3,57	133	33	4,03	135	30	4,49
220.2	100%	514	179	2,87	539	166	3,24	557	154	3,62	567	144	3,95
	75%	386	122	3,17	404	113	3,57	418	105	4,00	426	97	4,37
	50%	257	90	2,85	270	84	3,23	279	77	3,60	284	72	3,93
	25%	129	42	3,03	135	38	3,54	139	35	3,99	142	32	4,45
240.2	100%	560	191	2,93	588	177	3,31	608	164	3,70	618	153	4,03
	75%	420	129	3,25	441	120	3,67	456	111	4,10	464	103	4,49
	50%	280	96	2,92	294	89	3,30	304	83	3,68	309	77	4,02
	25%	140	46	3,04	147	41	3,56	152	38	4,01	155	35	4,47
260.2	100%	604	211	2,86	634	196	3,23	655	182	3,60	667	170	3,93
	75%	453	147	3,08	475	137	3,47	491	127	3,88	500	118	4,25
	50%	302	106	2,86	317	98	3,23	328	91	3,61	333	85	3,94
	25%	151	46	3,32	158	41	3,89	164	37	4,38	167	34	4,88
280.2	100%	669	238	2,82	702	221	3,18	726	204	3,55	738	191	3,87
	75%	502	170	2,95	526	158	3,32	544	146	3,72	554	136	4,07
	50%	335	120	2,79	351	111	3,15	363	103	3,52	369	96	3,84
	0,25	167	53	3,13	175	48	3,67	181	44	4,13	185	40	4,60
	100%	745	258	2,88	781	240	3,26	808	222	3,63	822	207	3,97
320.2	75%	559	183	3,06	586	170	3,45	606	157	3,86	616	146	4,22
	50%	372	130	2,85	391	121	3,23	404	112	3,60	411	104	3,93
	25%	186	60	3,11	195	54	3,64	202	49	4,10	205	45	4,57
	100%	782	277	2,82	820	257	3,19	848	239	3,55	863	222	3,88
340.2	75%	586	200	2,93	615	186	3,30	636	172	3,69	647	160	4,04
	50%	391	142	2,75	410	132	3,11	424	122	3,47	431	114	3,79
	25%	195	58	3,36	205	52	3,93	212	48	4,42	216	44	4,93
	100%	841	301	2,79	882	279	3,16	912	259	3,52	928	242	3,84
360.2	75%	630	219	2,88	661	204	3,25	684	188	3,63	696	175	3,97
	50%	420	153	2,75	441	142	3,11	456	131	3,47	464	122	3,79
	25%	210	66	3,18	220	59	3,72	228	54	4,19	232	50	4,67
	100%	922	331	2,78	967	308	3,14	1000	285	3,51	1017	266	3,83
400.2	50%	691	231	2,99	725	215	3,37	750	199	3,77	763	185	4,12
	50%	461	167	2,77	484	155	3,13	500	143	3,49	509	133	3,81
	25%	230	76	3,04	242	68	3,56	250	62	4,01	254	57	4,47

Size	Load	Entering external exchanger air temperature (°C)											
		35°C			30°C			25°C			20°C		
		kWf	kWe_tot	EER	kWf	kWe_tot	EER	kWf	kWe_tot	EER	kWf	kWe_tot	EER
440.2	100%	1033	375	2,76	1084	348	3,11	1120	322	3,47	1140	301	3,79
	75%	775	251	3,08	813	234	3,48	840	216	3,89	855	201	4,26
	50%	517	187	2,76	542	174	3,12	560	161	3,48	570	150	3,80
	25%	258	85	3,04	271	76	3,56	280	70	4,01	285	64	4,46
500.2	100%	1143	409	2,79	1199	380	3,16	1240	352	3,52	1262	328	3,84
	75%	857	272	3,15	899	253	3,55	930	234	3,97	946	218	4,34
	50%	572	205	2,79	600	190	3,16	620	176	3,52	631	164	3,85
	25%	286	91	3,14	300	82	3,67	310	75	4,13	315	68	4,61
540.2	100%	1263	453	2,79	1325	421	3,15	1369	390	3,51	1394	364	3,83
	75%	947	322	2,94	994	299	3,32	1027	277	3,71	1045	257	4,06
	50%	631	228	2,77	662	212	3,13	685	196	3,49	697	183	3,82
	25%	316	101	3,14	331	90	3,67	342	83	4,14	348	76	4,61
580.2	100%	1368	474	2,89	1435	440	3,26	1484	408	3,64	1510	381	3,97
	75%	1026	329	3,12	1076	306	3,51	1113	283	3,93	1132	263	4,30
	50%	684	239	2,87	718	221	3,24	742	205	3,62	755	191	3,95
	25%	342	106	3,22	359	95	3,77	371	87	4,24	377	80	4,73

Load = % of cooling capacity compared to the value at full load

kWf = Cooling capacity in kW

kWe_tot = Unit total power input in kW

The data do not consider the part related to the pumps, required to overcome the pressure drop for the solution circulation inside the exchangers

Internal exchanger water = leaving 7°C / entering 12°C / variable flow-rate with external exchanger air temperature

EXCELLENCE VERSION

Acoustic configuration: super-silenced (EN)

Cooling performance at part load

Size	Load	Entering external exchanger air temperature (°C)											
		35°C			30°C			25°C			20°C		
		kWf	kWe_tot	EER	kWf	kWe_tot	EER	kWf	kWe_tot	EER	kWf	kWe_tot	EER
200.2	100%	474	151	3,14	499	140	3,57	517	129	4,00	538	120	4,48
	75%	356	107	3,34	374	99	3,78	388	91	4,25	403	86	4,70
	50%	237	76	3,11	249	70	3,55	259	65	3,98	269	61	4,43
	25%	119	36	3,27	125	33	3,75	129	30	4,25	134	28	4,75
210.2	100%	502	160	3,14	528	148	3,58	548	136	4,03	569	127	4,49
	75%	377	111	3,40	396	102	3,88	411	94	4,36	427	88	4,86
	50%	251	80	3,14	264	74	3,58	274	68	4,03	285	63	4,49
	25%	126	36	3,45	132	34	3,93	137	31	4,42	142	29	4,92
220.2	100%	529	167	3,16	557	154	3,60	577	142	4,06	600	133	4,52
	75%	397	114	3,48	417	105	3,97	433	97	4,46	450	90	4,97
	50%	265	84	3,14	278	78	3,58	289	72	4,02	300	67	4,48
	25%	132	39	3,40	139	36	3,87	144	33	4,35	150	31	4,85
240.2	100%	571	181	3,16	601	167	3,61	623	154	4,06	647	143	4,52
	75%	428	124	3,45	451	115	3,93	467	106	4,42	486	99	4,92
	50%	286	91	3,15	300	84	3,58	311	77	4,03	324	72	4,49
	25%	143	44	3,24	150	41	3,69	156	38	4,15	162	35	4,62
260.2	100%	623	198	3,15	656	183	3,58	680	169	4,03	706	157	4,49
	75%	467	139	3,36	492	129	3,82	510	118	4,30	530	111	4,79
	50%	312	101	3,09	328	93	3,52	340	86	3,96	353	80	4,41
	25%	156	45	3,47	164	41	3,96	170	38	4,45	177	36	4,96
280.2	100%	692	218	3,17	728	201	3,62	755	186	4,07	785	173	4,53
	75%	519	156	3,33	546	144	3,79	566	133	4,26	589	124	4,75
	50%	346	110	3,14	364	102	3,57	377	94	4,02	392	88	4,48
	0,25	173	51	3,40	182	47	3,87	189	43	4,36	196	40	4,85
320.2	100%	744	227	3,28	783	209	3,74	812	193	4,20	844	180	4,68
	75%	558	160	3,48	587	148	3,96	609	136	4,46	633	127	4,97
	50%	372	114	3,26	391	105	3,72	406	97	4,18	422	91	4,66
	25%	186	55	3,37	196	51	3,84	203	47	4,32	211	44	4,82

Size	Load	Entering external exchanger air temperature (°C)											
		35°C			30°C			25°C			20°C		
		kWf	kWe_tot	EER	kWf	kWe_tot	EER	kWf	kWe_tot	EER	kWf	kWe_tot	EER
340.2	100%	822	254	3,23	865	235	3,68	897	216	4,14	932	202	4,62
	75%	617	184	3,34	649	170	3,81	673	157	4,29	699	146	4,77
	50%	411	130	3,15	432	120	3,59	448	111	4,04	466	104	4,50
	25%	206	55	3,77	216	50	4,29	224	46	4,83	233	43	5,38
360.2	100%	874	276	3,16	920	255	3,60	953	235	4,06	991	219	4,52
	75%	656	200	3,27	690	185	3,73	715	171	4,19	743	159	4,67
	50%	437	140	3,12	460	129	3,55	477	119	4,00	496	111	4,45
	25%	219	59	3,71	230	54	4,23	238	50	4,76	248	47	5,30
400.2	100%	962	304	3,17	1012	280	3,61	1049	258	4,06	1091	241	4,53
	50%	722	215	3,36	759	198	3,83	787	182	4,31	818	170	4,80
	50%	481	153	3,15	506	141	3,59	525	130	4,04	545	121	4,50
	25%	241	73	3,27	253	68	3,73	262	63	4,20	273	58	4,68
440.2	100%	1066	340	3,13	1122	314	3,57	1163	290	4,01	1209	270	4,47
	75%	800	245	3,26	841	227	3,71	872	209	4,18	907	195	4,65
	50%	533	174	3,07	561	160	3,50	581	148	3,94	604	138	4,39
	25%	267	80	3,32	280	74	3,78	291	68	4,25	302	64	4,74
500.2	100%	1173	372	3,15	1234	344	3,59	1280	317	4,04	1330	296	4,50
	75%	880	279	3,16	926	257	3,60	960	237	4,05	998	221	4,51
	50%	587	208	2,81	617	192	3,21	640	177	3,61	665	165	4,02
	25%	293	135	2,17	309	125	2,48	320	115	2,78	333	107	3,10

Load = % of cooling capacity compared to the value at full load

kWf = Cooling capacity in kW

kWe_tot = Unit total power input in kW

The data do not consider the part related to the pumps, required to overcome the pressure drop for the solution circulation inside the exchangers

Internal exchanger water = leaving 7°C / entering 12°C / variable flow-rate with external exchanger air temperature

PREMIUM VERSION

Acoustic configuration: super-silenced (EN)

Cooling performance at part load

Size	Load	Entering external exchanger air temperature (°C)											
		35°C			30°C			25°C			20°C		
		kWf	kWe_tot	EER	kWf	kWe_tot	EER	kWf	kWe_tot	EER	kWf	kWe_tot	EER
200.2	100%	448	164	2,73	471	152	3,11	489	140	3,50	508	130	3,90
	75%	336	113	2,98	354	104	3,39	367	96	3,82	381	90	4,25
	50%	224	83	2,71	236	76	3,09	244	70	3,48	254	66	3,88
	25%	112	38	2,97	118	35	3,39	122	32	3,81	127	30	4,25
210.2	100%	469	172	2,73	493	159	3,11	512	146	3,50	532	136	3,90
	75%	351,75	115	3,05	370	106	3,48	384	98	3,92	399	91	4,36
	50%	235	86	2,74	247	79	3,12	256	73	3,51	266	68	3,91
	25%	117	36	3,26	123	33	3,72	128	31	4,18	133	29	4,66
220.2	100%	504	178	2,83	530	164	3,23	550	151	3,63	572	141	4,04
	75%	378	116	3,26	398	107	3,72	412	99	4,18	429	92	4,66
	50%	252	89	2,82	265	82	3,22	275	76	3,62	286	71	4,03
	25%	126	38	3,30	133	35	3,76	137	32	4,23	143	30	4,71
240.2	100%	533	195	2,74	561	180	3,12	581	166	3,51	604	155	3,91
	75%	400	126	3,17	421	116	3,62	436	107	4,07	453	100	4,53
	50%	267	97	2,74	280	90	3,12	291	83	3,51	302	77	3,91
	25%	133	40	3,35	140	37	3,82	145	34	4,30	151	32	4,79
260.2	100%	593	214	2,77	624	198	3,16	647	182	3,55	672	170	3,96
	75%	445	147	3,03	468	135	3,46	485	125	3,89	504	116	4,33
	50%	297	105	2,82	312	97	3,21	323	90	3,61	336	84	4,02
	25%	148	44	3,40	156	40	3,88	162	37	4,36	168	35	4,86
280.2	100%	656	233	2,82	690	215	3,21	716	198	3,61	744	185	4,02
	75%	492	165	2,97	518	153	3,39	537	141	3,81	558	131	4,25
	50%	328	117	2,79	345	108	3,18	358	100	3,58	372	93	3,99
	0,25	164	51	3,25	173	47	3,70	179	43	4,16	186	40	4,64

Size	Load	Entering external exchanger air temperature (°C)											
		35°C			30°C			25°C			20°C		
		kWf	kWe_tot	EER	kWf	kWe_tot	EER	kWf	kWe_tot	EER	kWf	kWe_tot	EER
320.2	100%	723	255	2,83	761	236	3,23	789	217	3,63	820	203	4,04
	75%	542	177	3,07	571	163	3,49	592	150	3,93	615	140	4,38
	50%	362	128	2,82	380	118	3,22	394	109	3,62	410	102	4,03
	25%	181	55	3,29	190	51	3,75	197	47	4,21	205	44	4,69
340.2	100%	772	275	2,81	812	254	3,20	842	234	3,60	875	218	4,01
	75%	579	196	2,95	609	181	3,37	632	167	3,79	657	156	4,22
	50%	386	144	2,68	406	133	3,05	421	123	3,43	438	114	3,83
	25%	193	54	3,58	203	50	4,08	211	46	4,59	219	43	5,12
360.2	100%	829	297	2,79	872	274	3,18	904	253	3,58	940	236	3,98
	75%	622	212	2,93	654	196	3,34	678	181	3,75	705	169	4,18
	50%	415	150	2,76	436	139	3,15	452	128	3,54	470	119	3,94
	25%	207	58	3,60	218	53	4,10	226	49	4,62	235	46	5,14
400.2	100%	903	325	2,77	950	301	3,16	985	277	3,56	1024	258	3,96
	50%	677	225	3,02	713	207	3,44	739	191	3,87	768	178	4,31
	50%	452	163	2,76	475	151	3,15	493	139	3,54	512	130	3,95
	25%	226	69	3,26	238	64	3,72	246	59	4,18	256	55	4,66
440.2	100%	1017	361	2,82	1070	333	3,21	1109	307	3,61	1153	286	4,03
	75%	763	246	3,10	803	227	3,53	832	209	3,97	865	195	4,43
	50%	509	184	2,76	535	170	3,15	555	157	3,54	577	146	3,95
	25%	254	84	3,04	268	77	3,46	277	71	3,89	288	66	4,34
500.2	100%	1134	405	2,80	1193	374	3,19	1237	344	3,59	1286	321	4,00
	75%	851	269	3,16	895	249	3,60	928	229	4,05	964	214	4,51
	50%	567	201	2,81	597	186	3,21	619	171	3,61	643	160	4,02
	25%	284	91	3,13	298	84	3,56	309	77	4,01	321	72	4,47
540.2	100%	1243	441	2,82	1308	407	3,21	1356	375	3,61	1410	350	4,02
	75%	932	310	3,00	981	287	3,42	1017	264	3,85	1057	246	4,29
	50%	622	222	2,80	654	205	3,19	678	189	3,59	705	176	3,99
	25%	311	95	3,28	327	88	3,73	339	81	4,20	352	75	4,68
580.2	100%	1316	473	2,78	1385	436	3,17	1436	402	3,57	1492	375	3,98
	75%	987	324	3,04	1039	299	3,47	1077	276	3,90	1119	257	4,35
	50%	658	237	2,77	692	219	3,16	718	202	3,55	746	188	3,96
	25%	329	100	3,28	346	93	3,74	359	85	4,21	373	80	4,69

Load = % of cooling capacity compared to the value at full load

kWf = Cooling capacity in kW

kWe_tot = Unit total power input in kW

The data do not consider the part related to the pumps, required to overcome the pressure drop for the solution circulation inside the exchangers

Internal exchanger water = leaving 7°C / entering 12°C / variable flow-rate with external exchanger air temperature

Option compatibility - EXCELLENCE version

REF.	DESCRIPTION	200.2	210.2	220.2	240.2	260.2	280.2	320.2	340.2	360.2	400.2	440.2	500.2	540.2	580.2
CONFIGURATIONS AND MAIN ACCESSORIES															
B / D / R	Low water temperature / Partial energy recovery / Total energy recovery	0	0	0	0	0	0	0	0	0	0	0	0	0	0
D + R	Partial energy recovery + Total energy recovery	X	X	X	X	X	X	X	X	X	X	X	X	X	X
B + D	Low water temperature + Partial energy recovery	0	0	0	0	0	0	0	0	0	0	0	0	0	0
B + R	Low water temperature + Total energy recovery	0	0	0	0	0	0	0	0	0	0	0	0	0	0
2PM - HYDROPACK WITH NO.2 PUMPS															
D / R	Partial energy recovery / Total energy recovery	0	0	0	0	0	0	0	0	0	0	0	0	0	0
PUA2	2-pole A pump	Δ	Δ	Δ	Δ	0	Δ	Δ	X	X	X	X	X	X	X
PUB2	2-pole B pump	Δ	Δ	Δ	Δ	Δ	0	0	Δ	X	X	X	X	X	X
PUC2	2-pole C pump	X	X	X	X	0	Δ	Δ	Δ	Δ	Δ	Δ	Δ	X	X
PUD2	2-pole D pump	X	X	X	X	Δ	Δ	Δ	Δ	Δ	Δ	Δ	0	Δ	X
PUM4	4 poles M pump	Δ	Δ	Δ	Δ	Δ	0	0	X	X	X	X	X	X	X
PUN4	4-pole N pump	0	0	0	0	0	0	0	0	X	X	X	X	X	X
PUO4	4-pole O pump	0	0	0	0	0	0	0	0	0	X	X	X	X	X
PUP4	4-pole P pump	0	0	0	0	0	0	0	0	0	0	0	X	X	X
PUA2 + EN	2-pole A pump + Acoustic configuration: super-silenced (EN)	X	X	X	X	X	X	X	X	X	X	X	X	X	X
PUB2 + EN	2-pole B pump + Acoustic configuration: super-silenced (EN)	X	X	X	X	X	X	X	X	X	X	X	X	X	X
PUC2 + EN	2-pole C pump + Acoustic configuration: super-silenced (EN)	X	X	X	X	X	X	X	X	X	X	X	X	X	X
PUD2 + EN	2-pole D pump + Acoustic configuration: super-silenced (EN)	X	X	X	X	X	X	X	X	X	X	X	X	X	X
PUM4 + EN	4-pole M pump + Acoustic configuration: super-silenced (EN)	Δ	Δ	Δ	Δ	Δ	Δ	0	X	X	X	X	X	X	X
PUN4 + EN	4-pole N pump + Acoustic configuration: super-silenced (EN)	0	0	0	0	0	0	Δ	Δ	X	X	X	X	X	X
PUO4 + EN	4-pole O pump + Acoustic configuration: super-silenced (EN)	Δ	Δ	Δ	Δ	Δ	Δ	Δ	Δ	Δ	X	X	X	X	X
PUP4 + EN	4-pole P pump + Acoustic configuration: super-silenced (EN)	Δ	Δ	Δ	Δ	Δ	Δ	Δ	Δ	Δ	Δ	Δ	X	X	X
3PM - Hydropack with no. 3 pumps															
D / R	Partial energy recovery / Total energy recovery	0	0	0	0	0	0	0	0	0	0	0	0	0	0
PUC2	2-pole C pump	X	X	X	X	X	X	X	X	X	X	Δ	Δ	Δ	Δ
PUD2	2-pole D pump	X	X	X	X	X	X	X	X	Δ	Δ	Δ	Δ	Δ	Δ
PUO4	4-pole O pump	X	X	X	X	X	X	X	X	X	Δ	Δ	Δ	Δ	X
PUP4	4-pole P pump	X	X	X	X	X	Δ	Δ	Δ	Δ	0	0	0	0	Δ
PUC2 + EN	2-pole C pump + Extremely low noise configuration	X	X	X	X	X	X	X	X	X	X	X	X	X	X
PUD2 + EN	2-pole D pump + Extremely low noise acoustic configuration	X	X	X	X	X	X	X	X	X	X	X	X	X	X
PUO4 + EN	4-pole O pump + Extremely low noise acoustic configuration	X	X	X	X	X	X	X	X	X	Δ	Δ	Δ	X	X
PUP4 + EN	4-pole P pump + Extremely low noise acoustic configuration	X	X	X	X	X	Δ	Δ	Δ	Δ	Δ	Δ	Δ	X	X

x = Option not available

o = Available option

Δ = Recommended option (low-mid high head, wherever available)

Option compatibility - PREMIUM version

REF.	DESCRIPTION	200.2	210.2	220.2	240.2	260.2	280.2	320.2	340.2	360.2	400.2	440.2	500.2	540.2	580.2
CONFIGURATIONS AND MAIN ACCESSORIES															
B / D / R	Low water temperature / Partial energy recovery / Total energy recovery	0	0	0	0	0	0	0	0	0	0	0	0	0	0
D + R	Partial energy recovery + Total energy recovery	X	X	X	X	X	X	X	X	X	X	X	X	X	X
B + D	Low water temperature + Partial energy recovery	0	0	0	0	0	0	0	0	0	0	0	0	0	0
B + R	Low water temperature + Total energy recovery	0	0	0	0	0	0	0	0	0	0	0	0	0	0
2PM - HYDROPACK WITH NO.2 PUMPS															
D / R	Partial energy recovery / Total energy recovery	0	0	0	0	0	0	0	0	0	0	0	0	0	0
PUA2	2-pole A pump	△	△	△	△	0	△	△	X	X	X	X	X	X	X
PUB2	2-pole B pump	△	△	△	△	△	0	0	△	X	X	X	X	X	X
PUC2	2-pole C pump	X	X	X	X	0	△	△	△	△	△	△	△	X	X
PUD2	2-pole D pump	X	X	X	X	△	△	△	△	△	△	△	0	△	X
PUM4	4 poles M pump	△	△	△	△	△	0	0	X	X	X	X	X	X	X
PUN4	4-pole N pump	0	0	0	0	0	0	0	0	X	X	X	X	X	X
PU04	4-pole O pump	0	0	0	0	0	0	0	0	0	X	X	X	X	X
PUP4	4-pole P pump	0	0	0	0	0	0	0	0	0	0	0	X	X	X
PUA2 + EN	2-pole A pump + Extremely low noise configuration	X	X	X	X	X	X	X	X	X	X	X	X	X	X
PUB2 + EN	2-pole B pump + Extremely low noise configuration	X	X	X	X	X	X	X	X	X	X	X	X	X	X
PUC2 + EN	2-pole C pump + Extremely low noise configuration	X	X	X	X	X	X	X	X	X	X	X	X	X	X
PUD2 + EN	2-pole D pump + Extremely low noise acoustic configuration	X	X	X	X	X	X	X	X	X	X	X	X	X	X
PUM4 + EN	4-pole M pump + Extremely low noise acoustic configuration	△	△	△	△	△	△	0	X	X	X	X	X	X	X
PUN4 + EN	4-pole N pump + Extremely low noise acoustic configuration	0	0	0	0	0	0	△	△	X	X	X	X	X	X
PU04 + EN	4-pole O pump + Extremely low noise acoustic configuration	△	△	△	△	△	△	△	△	△	X	X	X	X	X
PUP4 + EN	4-pole P pump + Extremely low noise acoustic configuration	△	△	△	△	△	△	△	△	△	△	△	X	X	X
3PM - Hydropack with no. 3 pumps															
D / R	Partial energy recovery / Total energy recovery	0	0	0	0	0	0	0	0	0	0	0	0	0	0
PUC2	2-pole C pump	X	X	X	X	X	X	X	X	X	X	X	△	△	△
PUD2	2-pole D pump	X	X	X	X	X	X	X	X	X	△	△	△	△	△
PU04	4-pole O pump	X	X	X	X	X	X	X	X	X	△	△	△	△	△
PUP4	4-pole P pump	X	X	X	X	X	△	△	△	△	0	0	0	0	0
PUC2 + EN	2-pole C pump + Extremely low noise configuration	X	X	X	X	X	X	X	X	X	X	X	X	X	X
PUD2 + EN	2-pole D pump + Extremely low noise acoustic configuration	X	X	X	X	X	X	X	X	X	X	X	X	X	X
PU04 + EN	4-pole O pump + Extremely low noise acoustic configuration	X	X	X	X	X	X	X	X	X	△	△	△	△	△
PUP4 + EN	4-pole P pump + Extremely low noise acoustic configuration	X	X	X	X	X	△	△	△	△	△	△	△	△	△

x = Option not available

o = Available option

△ = Recommended option (low-mid high head, wherever available)

Dimensional drawings - EXCELLENCE version

Size 200.2-210.2 - Acoustic configuration: standard (ST) / Compressor soundproofing (SC)

DAA8E200 2_210 2_EXC_ST_SC_0

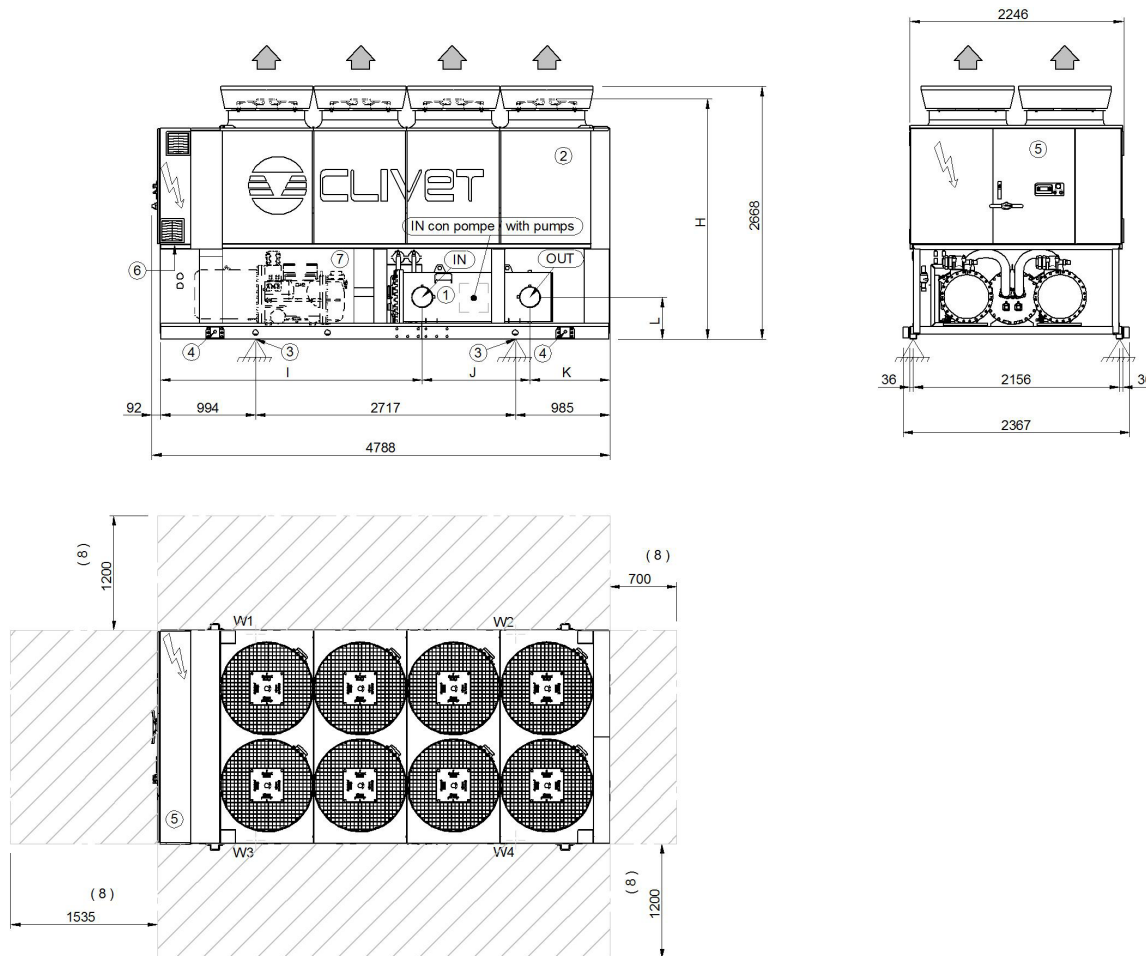

- 1. Internal exchanger (evaporator)
- 2. External exchanger (condenser)
- 3. Unit fixing holes
- 4. Lifting brackets (removable, if required, after the unit positioning)
- 5. Electrical panel
- 6. Power input
- 7. Sound proof enclosure (only in the relevant versions)
- 8. Clearance access recommended

Size		ST-EXC		SC-EXC	
		200.2	210.2	200.2	210.2
H	mm	2484	2484	2484	2484
I	mm	2735	2735	2735	2735
J	mm	1127	1127	1127	1127
K	mm	834	834	834	834
L	mm	437	437	437	437
OD	mm	8"	8"	8"	8"
A - Length	mm	4788	4788	4788	4788
B - Depth	mm	2246	2246	2246	2246
C - Height	mm	2668	2668	2668	2668
W1 Supporting point	kg	1262	1267	1357	1362
W2 Supporting point	kg	1079	1076	1122	1118
W3 Supporting point	kg	1280	1282	1377	1379
W4 Supporting point	kg	1097	1091	1142	1136
Shipping weight	kg	4484	4484	4764	4762
Operating weight	kg	4717	4715	4997	4995

The presence of optional accessories may result in a substantial variation of the weights shown in the table. Fan diffusers are separately supplied.

EXCELLENCE version

Size 220.2-260.2 - Acoustic configuration: standard (ST) / Compressor soundproofing (SC)

Size 200.2-220.2 - Acoustic configuration: super-silenced (EN)

DAA8E220 2_260 2_EXC_ST_SC_EN_0

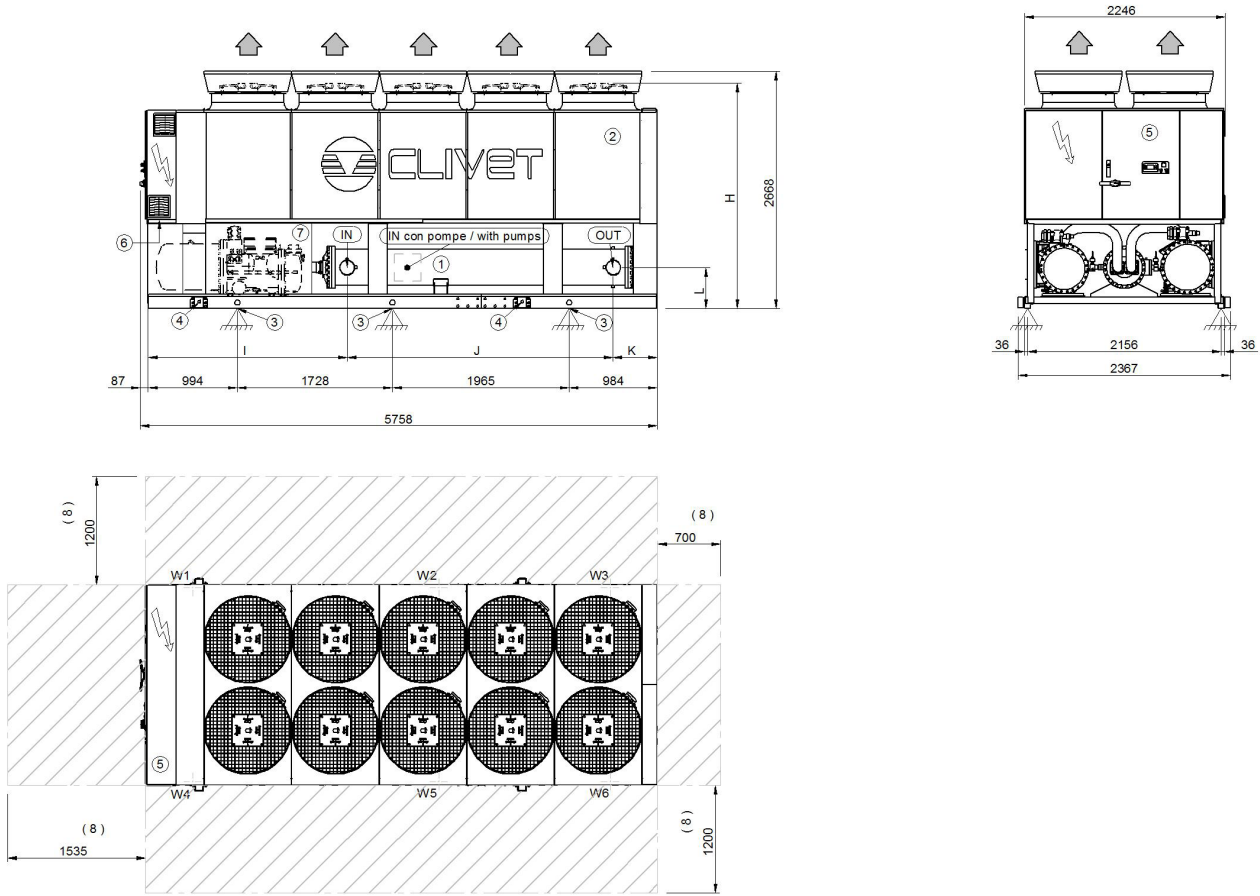

- 1. Internal exchanger (evaporator)
- 2. External exchanger (condenser)
- 3. Unit fixing holes
- 4. Lifting brackets (removable, if required, after the unit positioning)
- 5. Electrical panel
- 6. Power input
- 7. Sound proof enclosure (only in the relevant versions)
- 8. Clearance access recommended

Grandezze		ST-EXC			SC-EXC			EN-EXC		
		220.2	240.2	260.2	220.2	240.2	260.2	200.2	210.2	220.2
H	mm	2484	2484	2484	2484	2484	2484	2510	2510	2510
I	mm	2925	2925	2925	2925	2925	2925	2925	2925	2925
J	mm	2962	2962	2962	2962	2962	2962	2412	2412	2962
K	mm	759	759	759	759	759	759	1309	1309	759
L	mm	457	457	457	457	457	457	457	457	457
OD	mm	6"	6"	6"	6"	6"	6"	6"	6"	6"
A - Length	mm	5758	5758	5758	5758	5758	5758	5758	5758	5758
B - Depth	mm	2246	2246	2246	2246	2246	2246	2246	2246	2246
C - Height	mm	2668	2668	2668	2668	2668	2668	2668	2668	2668
W1 Supporting point	kg	1098	1115	1148	1242	1259	1292	1244	1272	1309
W2 Supporting point	kg	1075	1081	1084	1076	1082	1085	991	1012	1039
W3 Supporting point	kg	588	593	598	589	594	599	606	621	640
W4 Supporting point	kg	1049	1065	1109	1185	1201	1245	1186	1222	1250
W5 Supporting point	kg	1028	1033	1048	1027	1032	1046	945	972	992
W6 Supporting point	kg	562	567	578	562	566	577	578	596	611
Shipping weight	kg	5094	5147	5258	5374	5427	5538	5244	5389	5534
Operating weight	kg	5401	5454	5565	5681	5734	5845	5551	5696	5841

The presence of optional accessories may result in a substantial variation of the weights shown in the table. Fan diffusers are separately supplied.

EXCELLENCE version

Size 280.2-320.2 - Acoustic configuration: standard (ST) / Compressor soundproofing (SC)

Size 240.2-260.2 - Acoustic configuration: super-silenced (EN)

DAA8E280 2_320 2_EXC_ST_SC_EN_0

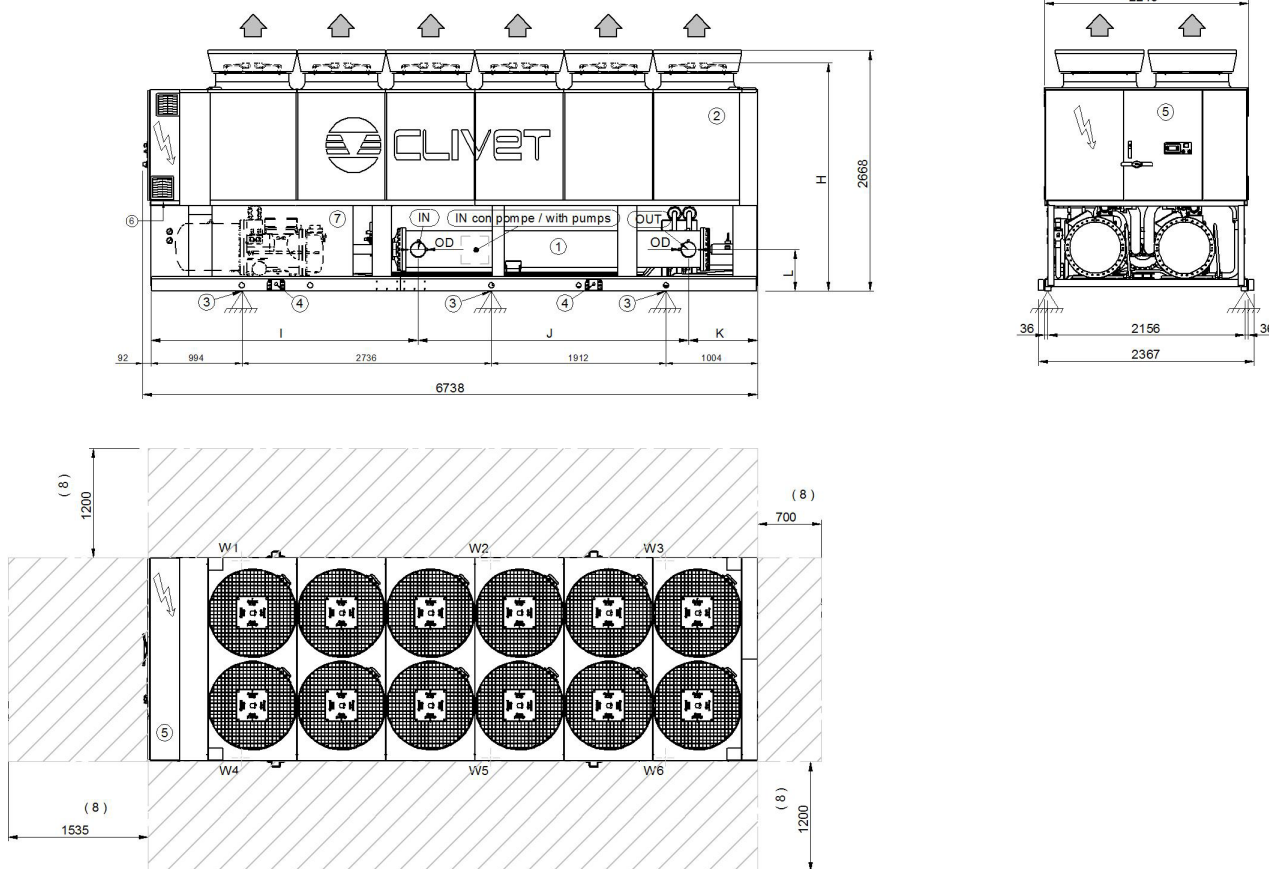

- 1. Internal exchanger (evaporator)
- 2. External exchanger (condenser)
- 3. Unit fixing holes
- 4. Lifting brackets (removable, if required, after the unit positioning)
- 5. Electrical panel
- 6. Power input
- 7. Sound proof enclosure (only in the relevant versions)
- 8. Clearance access recommended

Size		ST-EXC		SC-EXC		EN-EXC	
		280.2	320.2	280.2	320.2	240.2	260.2
H	mm	2484	2484	2484	2484	2510	2510
I	mm	2925	2925	2925	2925	2925	2925
J	mm	2962	2962	2962	2962	2962	2962
K	mm	759	759	759	759	759	759
L	mm	457	457	457	457	457	457
OD	mm	6"	6"	6"	6"	6"	6"
A - Length	mm	6738	6738	6738	6738	6738	6738
B - Depth	mm	2246	2246	2246	2246	2246	2246
C - Height	mm	2668	2668	2668	2668	2668	2668
W1 Supporting point	kg	1424	1483	1544	1602	1451	1508
W2 Supporting point	kg	1158	1188	1192	1222	1134	1176
W3 Supporting point	kg	527	537	520	530	499	521
W4 Supporting point	kg	1365	1421	1476	1532	1388	1458
W5 Supporting point	kg	1109	1138	1140	1169	1084	1137
W6 Supporting point	kg	505	515	497	507	477	504
Shipping weight	kg	5808	6002	6088	6282	5726	5996
Operating weight	kg	6088	6282	6368	6562	6033	6303

The presence of optional accessories may result in a substantial variation of the weights shown in the table. Fan diffusers are separately supplied.

EXCELLENCE version

Size 340.2-360.2 - Acoustic configuration: standard (ST) / Compressor soundproofing (SC)

Size 280.2 - Acoustic configuration: super-silenced (EN)

DAA8E340 2_360 2_EXC_ST_SC_EN_0

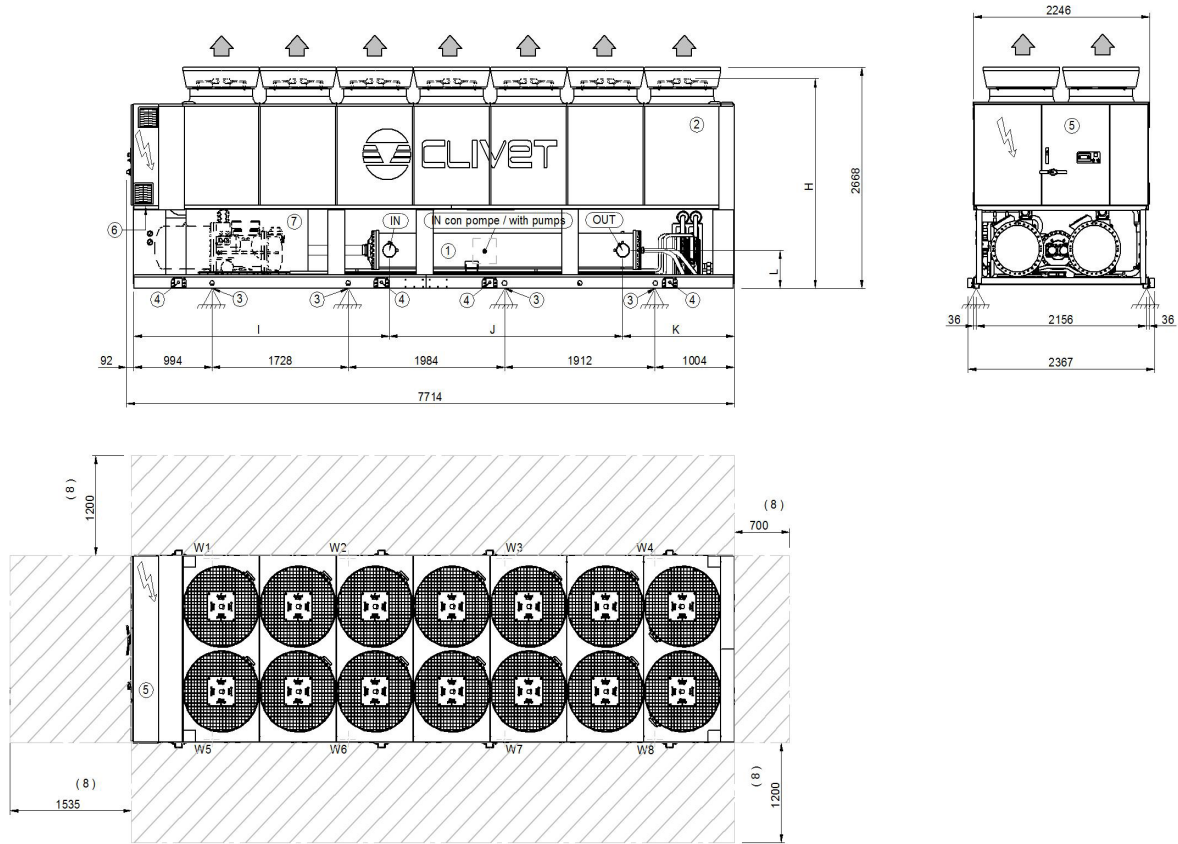

- 1. Internal exchanger (evaporator)
- 2. External exchanger (condenser)
- 3. Unit fixing holes
- 4. Lifting brackets (removable, if required, after the unit positioning)
- 5. Electrical panel
- 6. Power input
- 7. Sound proof enclosure (only in the relevant versions)
- 8. Clearance access recommended

Size		ST-EXC		SC-EXC		EN-EXC
		340.2	360.2	340.2	360.2	280.2
H	mm	2484	2484	2484	2484	2510
I	mm	3245	3245	3245	3245	2980
J	mm	2962	2962	2962	2962	2910
K	mm	1415	1415	1415	1415	1732
L	mm	457	457	457	457	457
OD	mm	6"	6"	6"	6"	6"
A - Length	mm	7714	7714	7714	7714	7714
B - Depth	mm	2246	2246	2246	2246	2246
C - Height	mm	2668	2668	2668	2668	2668
W1 Supporting point	kg	1434	1578	1550	1694	1339
W2 Supporting point	kg	760	825	794	858	923
W3 Supporting point	kg	802	819	802	819	713
W4 Supporting point	kg	586	607	586	607	580
W5 Supporting point	kg	1406	1475	1509	1578	1281
W6 Supporting point	kg	746	771	773	799	883
W7 Supporting point	kg	764	781	764	781	682
W8 Supporting point	kg	558	579	558	579	555
Shipping weight	kg	6775	7155	7055	7435	6676
Operating weight	kg	7055	7435	7335	7715	6956

The presence of optional accessories may result in a substantial variation of the weights shown in the table. Fan diffusers are separately supplied.

EXCELLENCE version

Size 400.2-440.2 - Acoustic configuration: standard (ST) / compressor soundproofing (SC)

Size 320.2-360.2 - Acoustic configuration: super-silenced (EN)

DAA8E400 2_440 2_EXC_ST_SC_EN_0

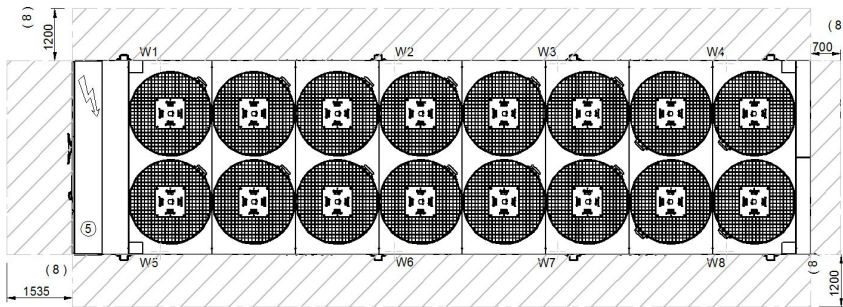
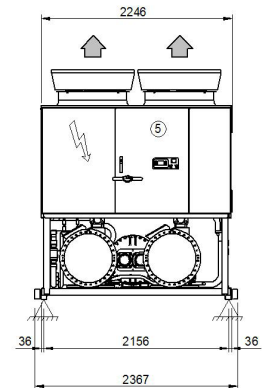
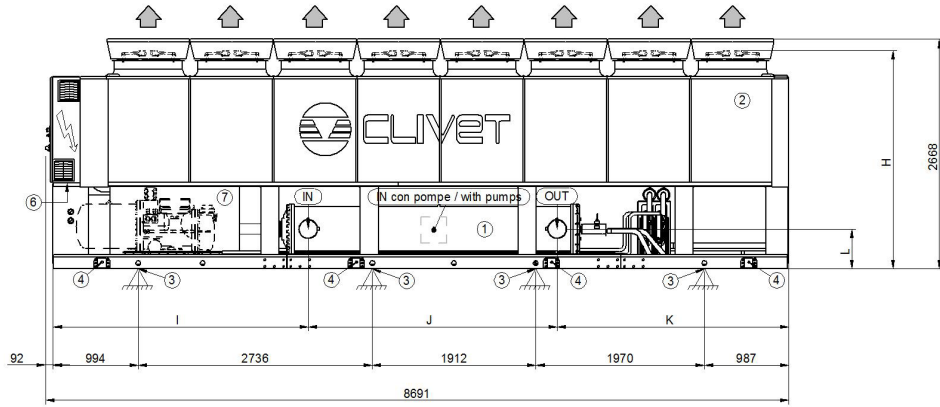

- 1. Internal exchanger (evaporator)
- 2. External exchanger (condenser)
- 3. Unit fixing holes
- 4. Lifting brackets (removable, if required, after the unit positioning)
- 5. Electrical panel
- 6. Power input
- 7. Sound proof enclosure (only in the relevant versions)
- 8. Clearance access recommended

Size		ST-EXC		SC-EXC		EN-EXC		
		400.2	440.2	400.2	440.2	320.2	340.2	360.2
H	mm	2484	2484	2484	2484	2510	2510	2510
I	mm	2980	2980	2980	2980	3245	3245	3245
J	mm	2910	2910	2910	2910	2962	2962	2962
K	mm	2709	2709	2709	2709	2392	2392	2392
L	mm	457	457	457	457	457	457	457
OD	mm	8"	8"	8"	8"	6"	6"	6"
A - Length	mm	8691	8691	8691	8691	8691	8691	8691
B - Depth	mm	2246	2246	2246	2246	2246	2246	2246
C - Height	mm	2668	2668	2668	2668	2668	2668	2668
W1 Supporting point	kg	1496	1520	1603	1627	1466	1529	1641
W2 Supporting point	kg	1069	1088	1108	1127	961	980	1042
W3 Supporting point	kg	978	1003	978	1003	844	851	858
W4 Supporting point	kg	555	563	555	563	563	571	579
W5 Supporting point	kg	1429	1453	1528	1552	1404	1518	1568
W6 Supporting point	kg	1021	1040	1056	1075	921	972	995
W7 Supporting point	kg	935	959	935	959	809	817	824
W8 Supporting point	kg	530	538	530	538	540	548	557
Shipping weight	kg	7532	7684	7812	7964	7228	7506	7784
Operating weight	kg	8013	8165	8293	8445	7508	7786	8064

The presence of optional accessories may result in a substantial variation of the weights shown in the table. Fan diffusers are separately supplied.

EXCELLENCE version

Size 500.2-580.2 - Acoustic configuration: standard (ST) / compressor soundproofing (SC)

Size 400.2-500.2 - Acoustic configuration: super-silenced (EN)

DAA8E500 2_580 2_EXC_ST_SC_EN_0

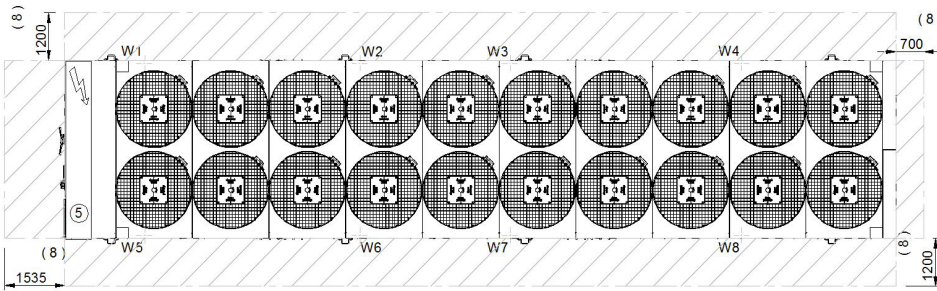
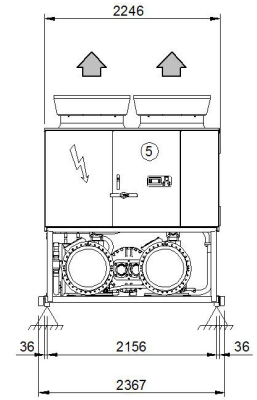
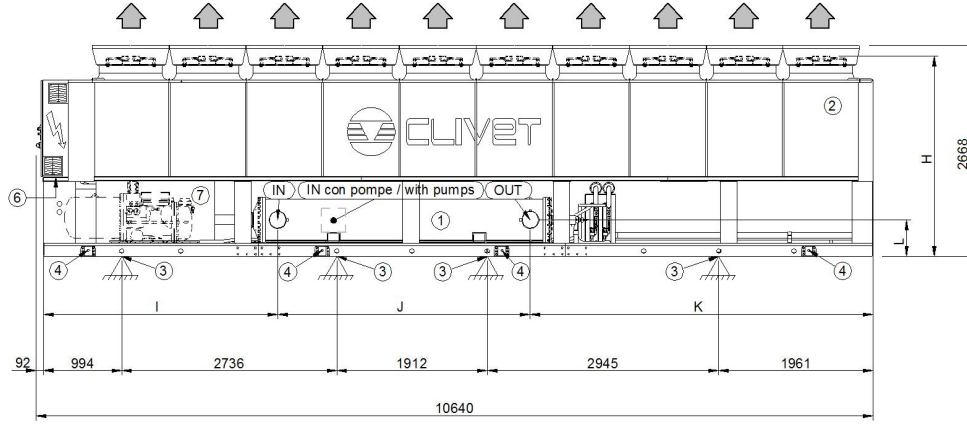

- 1. Internal exchanger (evaporator)
- 2. External exchanger (condenser)
- 3. Unit fixing holes
- 4. Lifting brackets (removable, if required, after the unit positioning)
- 5. Electrical panel
- 6. Power input
- 7. Sound proof enclosure (only in the relevant versions)
- 8. Clearance access recommended

Size		ST-EXC			SC-EXC			EN-EXC		
		500.2	540.2	580.2	500.2	540.2	580.2	400.2	440.2	500.2
H	mm	2484	2484	2484	2484	2484	2484	2510	2510	2510
I	mm	2980	2980	2980	2980	2980	2980	2980	2980	2980
J	mm	3210	3210	3210	3210	3210	3210	2910	2910	3210
K	mm	4359	4359	4359	4359	4359	4359	4659	4659	4359
L	mm	457	457	457	457	457	457	457	457	457
OD	mm	8"	8"	8"	8"	8"	8"	8"	8"	8"
A - Length	mm	10640	10640	10640	10640	10640	10640	10640	10640	10640
B - Depth	mm	2246	2246	2246	2246	2246	2246	2246	2246	2246
C - Height	mm	2668	2668	2668	2668	2668	2668	2668	2668	2668
W1 Supporting point	kg	1749	1838	1886	1876	1966	2014	1832	1873	1929
W2 Supporting point	kg	1081	1123	1148	1099	1141	1166	1065	1097	1148
W3 Supporting point	kg	926	962	986	926	962	986	907	938	976
W4 Supporting point	kg	601	637	657	601	637	657	595	626	652
W5 Supporting point	kg	1668	1754	1801	1787	1873	1920	1746	1787	1840
W6 Supporting point	kg	1031	1072	1096	1047	1088	1111	1015	1046	1095
W7 Supporting point	kg	892	928	953	892	928	953	872	904	943
W8 Supporting point	kg	579	615	634	579	615	634	572	604	630
Shipping weight	kg	8014	8417	8647	8294	8697	8927	8124	8396	8698
Operating weight	kg	8527	8930	9160	8807	9210	9440	8604	8879	9211

The presence of optional accessories may result in a substantial variation of the weights shown in the table. Fan diffusers are separately supplied.

Dimensional drawings - PREMIUM version

Size 200.2-260.2 - Acoustic configuration: standard (ST) / Compressor soundproofing (SC)

Size 200.2-240.2 - Acoustic configuration: super-silenced (EN)

DAA8E200 2_260 2_PRM_ST_SC_EN_0

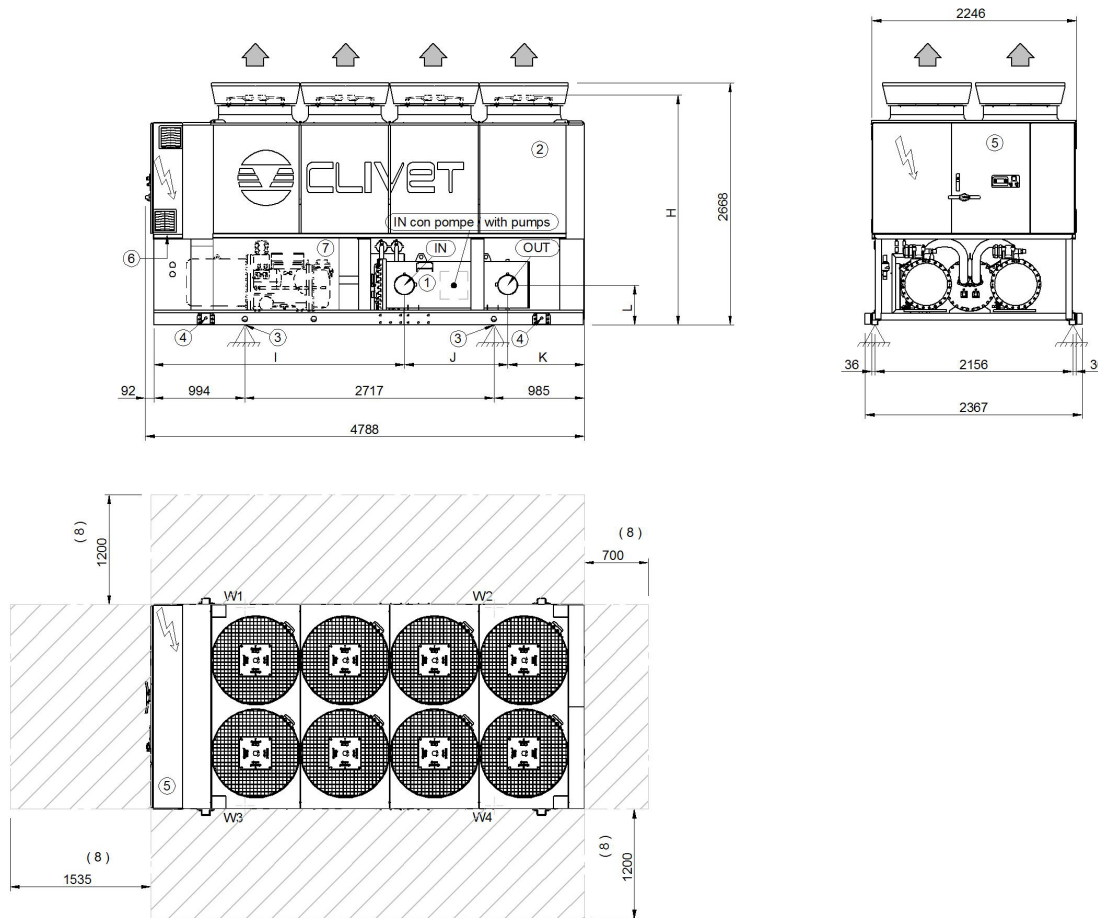

1. Internal exchanger (evaporator)
2. External exchanger (condenser)
3. Unit fixing holes
4. Lifting brackets (removable, if required, after the unit positioning)
5. Electrical panel
6. Power input
7. Sound proof enclosure (only in the relevant versions)
8. Clearance access recommended

Size		ST-PRM					SC-PRM					EN-PRM			
		200.2	210.2	220.2	240.2	260.2	200.2	210.2	220.2	240.2	260.2	200.2	210.2	220.2	240.2
H	mm	2484	2484	2484	2484	2484	2484	2484	2484	2484	2484	2510	2510	2510	2510
I	mm	2735	2735	2735	2735	2735	2735	2735	2735	2735	2735	2735	2735	2735	2735
J	mm	1127	1127	1127	1127	1127	1127	1127	1127	1127	1127	1127	1127	1127	1127
K	mm	834	834	834	834	834	834	834	834	834	834	834	834	834	834
L	mm	437	437	437	437	437	437	437	437	437	437	437	437	437	437
OD	mm	8"	8"	8"	8"	8"	8"	8"	8"	8"	8"	8"	8"	8"	8"
A - Length	mm	4788	4788	4788	4788	4788	4788	4788	4788	4788	4788	4788	4788	4788	4788
B - Depth	mm	2246	2246	2246	2246	2246	2246	2246	2246	2246	2246	2246	2246	2246	2246
C - Height	mm	2668	2668	2668	2668	2668	2668	2668	2668	2668	2668	2668	2668	2668	2668
W1 Supporting point	kg	1243	1253	1261	1290	1324	1338	1348	1355	1384	1419	1338	1358	1386	1396
W2 Supporting point	kg	1048	1054	1056	1092	1116	1091	1096	1099	1134	1159	1091	1112	1148	1153
W3 Supporting point	kg	1261	1268	1279	1308	1335	1358	1366	1376	1406	1433	1358	1375	1407	1417
W4 Supporting point	kg	1066	1068	1074	1110	1127	1111	1114	1119	1155	1173	1111	1130	1169	1174
Shipping weight	kg	4384	4410	4436	4566	4670	4664	4690	4716	4846	4950	4664	4742	4876	4906
Operating weight	kg	4617	4643	4669	4799	4903	4897	4923	4949	5079	5183	4897	4975	5109	5139

The presence of optional accessories may result in a substantial variation of the weights shown in the table. Fan diffusers are separately supplied.

PREMIUM version

Size 280.2-320.2 - Acoustic configuration: standard (ST) / Compressor soundproofing (SC)

Size 260.2-280.2 - Acoustic configuration: super-silenced (EN)

DAA8E280 2_320 2_PRM_ST_SC_EN_0

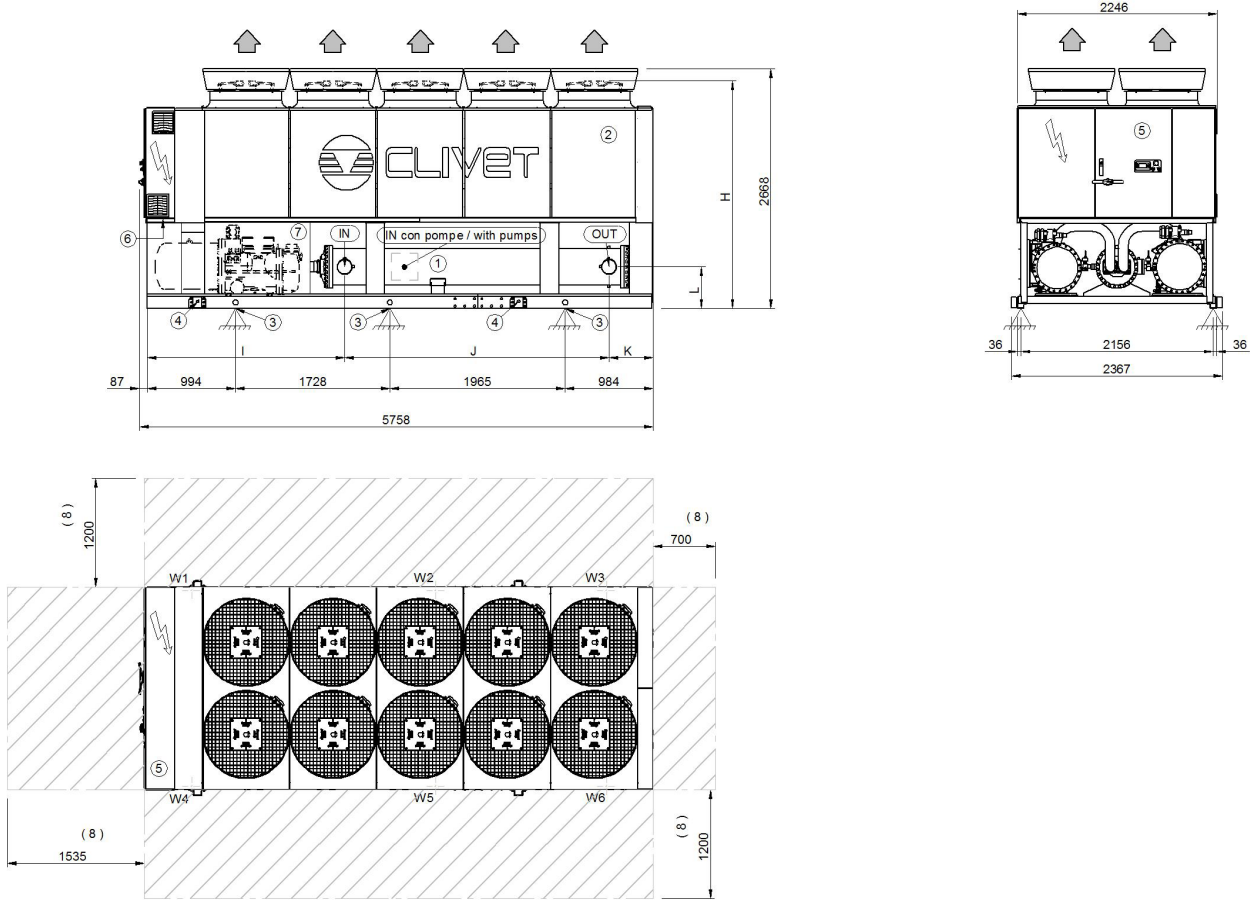

- 1. Internal exchanger (evaporator)
- 2. External exchanger (condenser)
- 3. Unit fixing holes
- 4. Lifting brackets (removable, if required, after the unit positioning)
- 5. Electrical panel
- 6. Power input
- 7. Sound proof enclosure (only in the relevant versions)
- 8. Clearance access recommended

Size		ST-PRM		SC-PRM		EN-PRM	
		280.2	320.2	280.2	320.2	260.2	280.2
H	mm	2484	2484	2484	2484	2510	2510
I	mm	2925	2925	2925	2925	2925	2925
J	mm	2962	2962	2962	2962	2412	2962
K	mm	759	759	759	759	1309	759
L	mm	457	457	457	457	457	457
OD	mm	6"	6"	6"	6"	6"	6"
A - Length	mm	5758	5758	5758	5758	5758	5758
B - Depth	mm	2246	2246	2246	2246	2246	2246
C - Height	mm	2668	2668	2668	2668	2668	2668
W1 Supporting point	kg	1242	1280	1349	1387	1339	1402
W2 Supporting point	kg	1002	1018	1046	1062	1044	1078
W3 Supporting point	kg	627	625	622	620	627	635
W4 Supporting point	kg	1186	1221	1285	1321	1300	1336
W5 Supporting point	kg	957	971	997	1012	1014	1027
W6 Supporting point	kg	599	597	592	590	609	605
Shipping weight	kg	5305	5405	5585	5685	5626	5776
Operating weight	kg	5612	5712	5892	5992	5933	6083

The presence of optional accessories may result in a substantial variation of the weights shown in the table. Fan diffusers are separately supplied.

PREMIUM version

Size 340.2-400.2 - Acoustic configuration: standard (ST) / Compressor soundproofing (SC)

Size 320.2-340.2 - Acoustic configuration: super-silenced (EN)

DAA8E340 2_400 2_PRM_ST_SC_EN_0

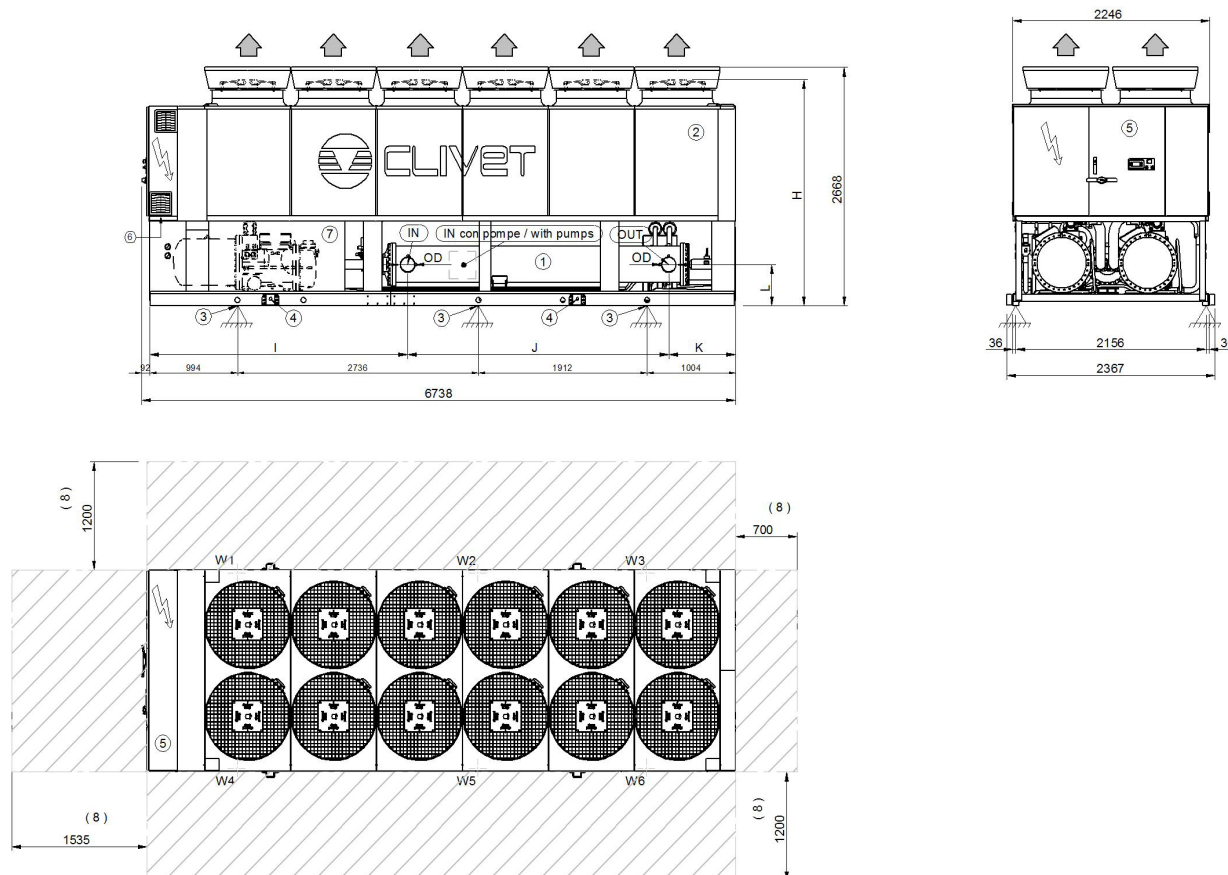

- | | |
|--|--|
| 1. Internal exchanger (evaporator) | 5. Electrical panel |
| 2. External exchanger (condenser) | 6. Power input |
| 3. Unit fixing holes | 7. Sound proof enclosure (only in the relevant versions) |
| 4. Lifting brackets (removable, if required, after the unit positioning) | 8. Clearance access recommended |

Size		ST-PRM			SC-PRM			EN-PRM	
		340.2	360.2	400.2	340.2	360.2	400.2	320.2	340.2
H	mm	2484	2484	2484	2484	2484	2484	2510	2510
I	mm	2925	2925	2925	2925	2925	2925	2925	2925
J	mm	2962	2962	2962	2962	2962	2962	2962	2962
K	mm	759	759	759	759	759	759	759	759
L	mm	457	457	457	457	457	457	457	457
OD	mm	6"	6"	6"	6"	6"	6"	6"	6"
A - Length	mm	6738	6738	6738	6738	6738	6738	6738	6738
B - Depth	mm	2246	2246	2246	2246	2246	2246	2246	2246
C - Height	mm	2668	2668	2668	2668	2668	2668	2668	2668
W1 Supporting point	kg	1678	1673	1715	1681	1793	1835	1581	1666
W2 Supporting point	kg	1151	1235	1272	1143	1269	1306	1193	1221
W3 Supporting point	kg	468	498	521	460	490	513	513	512
W4 Supporting point	kg	1600	1594	1636	1650	1706	1748	1511	1636
W5 Supporting point	kg	1098	1177	1213	1121	1207	1244	1141	1199
W6 Supporting point	kg	446	474	497	451	466	489	490	503
Shipping weight	kg	6135	6170	6373	6199	6450	6653	6122	6430
Operating weight	kg	6442	6651	6854	6506	6931	7134	6429	6737

The presence of optional accessories may result in a substantial variation of the weights shown in the table. Fan diffusers are separately supplied.

PREMIUM version

Size 440.2-500.2 - Acoustic configuration: standard (ST) / Compressor soundproofing (SC)

Size 360.2-400.2 - Acoustic configuration: super-silenced (EN)

DAA8E440 2_500 2_PRM_ST_SC_EN_0

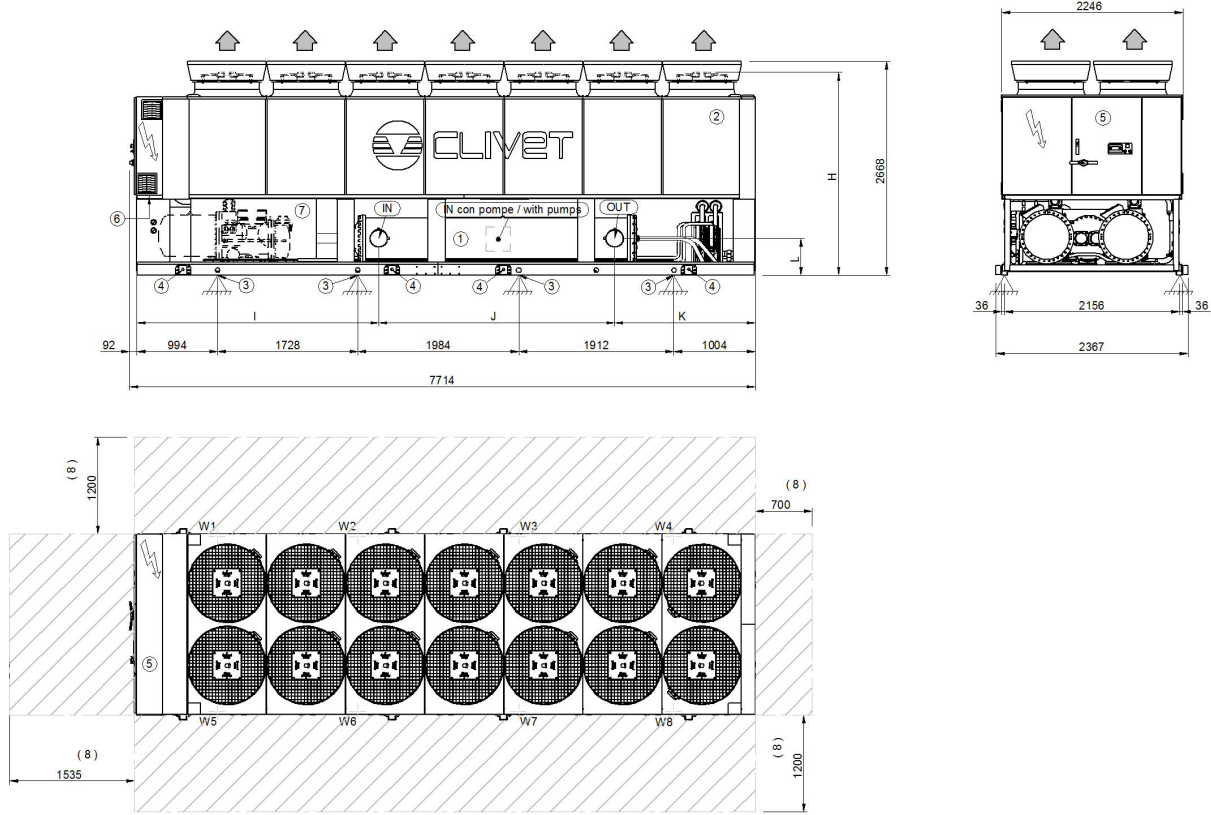

- 1. Internal exchanger (evaporator)
- 2. External exchanger (condenser)
- 3. Unit fixing holes
- 4. Lifting brackets (removable, if required, after the unit positioning)
- 5. Electrical panel
- 6. Power input
- 7. Sound proof enclosure (only in the relevant versions)
- 8. Clearance access recommended

Size		ST-PRM		SC-PRM		EN-PRM	
		440.2	500.2	440.2	500.2	360.2	400.2
H	mm	2484	2484	2484	2484	2510	2510
I	mm	2980	2980	2980	2980	2980	2980
J	mm	2910	2910	2910	2910	3210	3210
K	mm	1732	1732	1732	1732	1432	1432
L	mm	457	457	457	457	457	457
OD	mm	8"	8"	8"	8"	8"	8"
A - Length	mm	7714	7714	7714	7714	7714	7714
B - Depth	mm	2246	2246	2246	2246	2246	2246
C - Height	mm	2668	2668	2668	2668	2668	2668
W1 Supporting point	kg	1464	1514	1573	1624	1535	1500
W2 Supporting point	kg	952	978	989	1015	1004	1358
W3 Supporting point	kg	909	924	909	924	757	784
W4 Supporting point	kg	618	633	618	633	537	655
W5 Supporting point	kg	1398	1446	1499	1547	1462	1378
W6 Supporting point	kg	909	934	942	967	957	1248
W7 Supporting point	kg	864	879	864	879	723	725
W8 Supporting point	kg	587	602	587	602	513	606
Shipping weight	kg	7221	7431	7501	7711	7208	7774
Operating weight	kg	7701	7911	7981	8191	7488	8254

The presence of optional accessories may result in a substantial variation of the weights shown in the table. Fan diffusers are separately supplied.

PREMIUM version

Size 540.2-580.2 - Acoustic configuration: standard (ST) / compressor soundproofing (SC)

Size 440.2 - Acoustic configuration: super-silenced (EN)

DAA8E540 2_580 2_PRM_ST_SC_EN_0

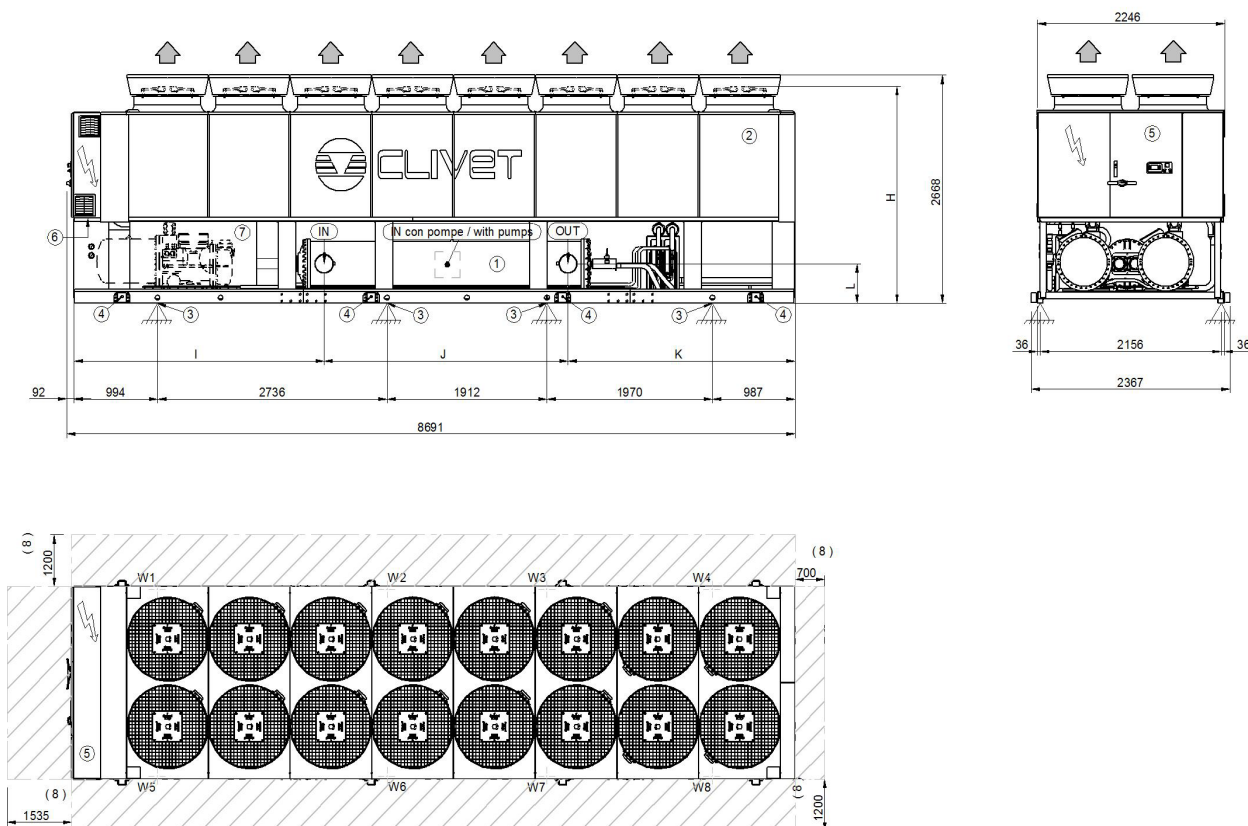

- | | |
|--|--|
| 1. Internal exchanger (evaporator) | 5. Electrical panel |
| 2. External exchanger (condenser) | 6. Power input |
| 3. Unit fixing holes | 7. Sound proof enclosure (only in the relevant versions) |
| 4. Lifting brackets (removable, if required, after the unit positioning) | 8. Clearance access recommended |

Size		ST-PRM		SC-PRM		EN-PRM
		540.2	580.2	540.2	580.2	440.2
H	mm	2484	2484	2484	2484	2510
I	mm	2980	2980	2980	2980	2980
J	mm	3210	3210	3210	3210	2910
K	mm	2409	2409	2409	2409	2709
L	mm	457	457	457	457	457
OD	mm	8"	8"	8"	8"	8"
A - Length	mm	8691	8691	8691	8691	8691
B - Depth	mm	2246	2246	2246	2246	2246
C - Height	mm	2668	2668	2668	2668	2668
W1 Supporting point	kg	1537	1573	1643	1679	1591
W2 Supporting point	kg	1255	1278	1295	1318	1228
W3 Supporting point	kg	892	910	892	910	838
W4 Supporting point	kg	561	572	561	572	576
W5 Supporting point	kg	1462	1496	1560	1594	1515
W6 Supporting point	kg	1194	1216	1230	1252	1169
W7 Supporting point	kg	855	873	855	873	804
W8 Supporting point	kg	537	549	537	549	553
Shipping weight	kg	7596	7770	7876	8050	7794
Operating weight	kg	8293	8467	8573	8747	8274

The presence of optional accessories may result in a substantial variation of the weights shown in the table. Fan diffusers are separately supplied.

PREMIUM version

Size 500.2-580.2 - Acoustic configuration: super-silenced (EN)

DAA8E500 2_580 2_PRM_EN_0

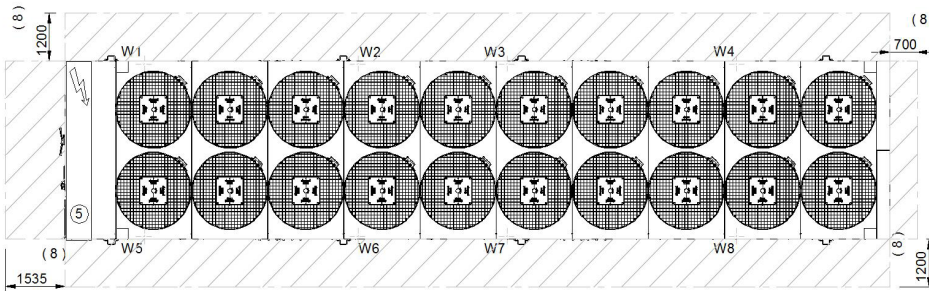
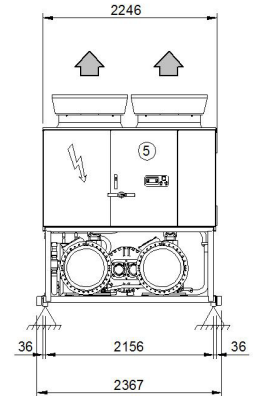
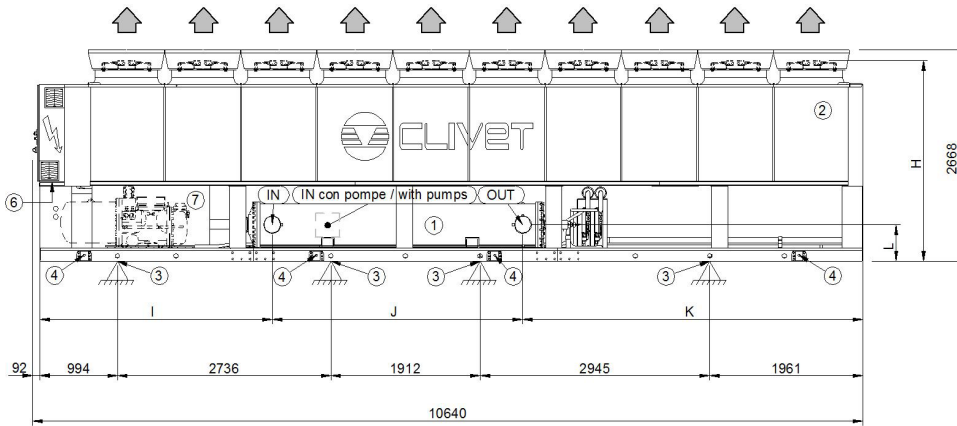

- 1. Internal exchanger (evaporator)
- 2. External exchanger (condenser)
- 3. Unit fixing holes
- 4. Lifting brackets (removable, if required, after the unit positioning)
- 5. Electrical panel
- 6. Power input
- 7. Sound proof enclosure (only in the relevant versions)
- 8. Clearance access recommended

Size		EN-PRM		
		500.2	540.2	580.2
H	mm	2510	2510	2510
I	mm	2980	2980	2980
J	mm	2910	3210	3210
K	mm	4659	4359	4359
L	mm	457	457	457
OD	mm	8"	8"	8"
A - Length	mm	10640	10640	10640
B - Depth	mm	2246	2246	2246
C - Height	mm	2668	2668	2668
W1 Supporting point	kg	1888	1966	2014
W2 Supporting point	kg	1077	1141	1166
W3 Supporting point	kg	905	962	986
W4 Supporting point	kg	604	637	657
W5 Supporting point	kg	1799	1873	1920
W6 Supporting point	kg	1026	1088	1111
W7 Supporting point	kg	873	928	953
W8 Supporting point	kg	583	615	634
Shipping weight	kg	8274	8697	8927
Operating weight	kg	8754	9210	9440

The presence of optional accessories may result in a substantial variation of the weights shown in the table. Fan diffusers are separately supplied.

Page intentionally left blank

**CLIVET SPA**

Via Camp Lonc 25, Z.I. Villapaiera - 32032 Feltre (BL) - Italy
Tel. + 39 0439 3131 - Fax + 39 0439 313300 - info@clivet.it

CLIVET UK LTD (Sales)

4 Kingdom Close, Segensworth East - Fareham, Hampshire - PO15 5TJ - United Kingdom
Tel. + 44 (0) 1489 572238 - Fax + 44 (0) 1489 573033 - info@clivet-uk.co.uk

CLIVET AIRCON LTD (Service and Maintenance Division)

Units F5&F6 Railway Triangle Ind EST, Walton Road - Portsmouth, Hampshire - PO6 1 TG - United Kingdom
Tel. + 44 (0) 2392 381235 - Fax + 44 (0) 2392 381243 - info@clivetaircon.co.uk

CLIVET ESPAÑA COMERCIAL S.L. (Sales)

Calle Gurb, 17 1º 1ª - 08500 Vic, Barcelona - España
Tel. + 34 93 8606248 - Fax + 34 93 8855392 - info@clivetcomercial.es

CLIVET ESPAÑA S.A.U. (Service and Maintenance Division)

Calle Real de Burgos nº12 - 28860, Paracuellos del Jarama, Madrid - España
Tel. + 34 91 6658280 - Fax + 34 91 6657806 - info@clivet.es

CLIVET GmbH

Hummelsbütteler Steindamm 84, 22851 Norderstedt - Germany
Tel. + 49 (0) 40 32 59 57-0 - Fax + 49 (0) 40 32 59 57-194 - info.de@clivet.com

CLIVET NEDERLAND B.V.

Siliciumweg 20a, 3812 SX Amersfoort - Netherlands
Tel. + 31 (0) 33 7503420 - Fax + 31 (0) 33 7503424 - info@clivet.nl

CLIVET RUSSIA

Elektrozavodskaya st. 24, office 509 - 107023, Moscow, Russia
Tel. + 74956462009 - Fax + 74956462009 - info.ru@clivet.com

CLIVET MIDEAST FZCO

Dubai Silicon Oasis (DSO), High Bay Complex, Ind Unit No. 3 - PO Box 28178 - DUBAI, UAE
Tel. + 97 14 3208499 - Fax + 97 14 3208216 - info@clivet.ae

CLIVET AIRCONDITIONING SYSTEMS PRIVATE LTD

3C3, Gundecha Onclave - Kherani Road, Saki Naka, Andheri (East), Mumbai 400 072 (INDIA)
Tel. + 91 - 22 - 6193 7000 - Fax + 91 - 22 - 6193 7001 - sales.india@clivet.com